

德思宏

压力不够 解决方案

SOLUTIONS OF HIGH PRESSURE
BOOST YOUR LIQUID PRESSURE

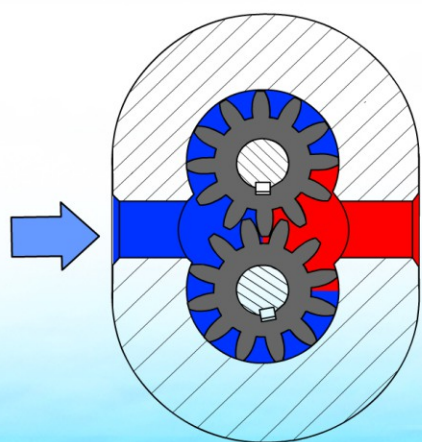

低压

LOW

+

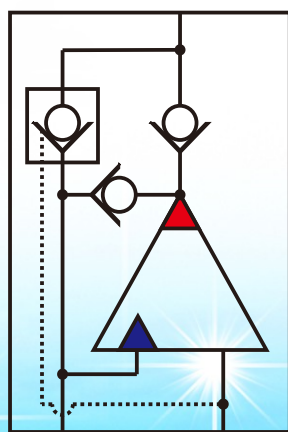

增压

BOOSTER



500bar
700bar
800bar
2000bar
2400bar
2800bar
4000bar

高压

HIGH

公司简介

德思宏液压是中国一家拥有液压增压器自主研发能力的企业,公司生产基地位于江西宜丰工业园区,占地10亩。德思宏液压工程师对液压增压器的研究发起于2007年,在对国内外各种液压增压器进行深入研究后,充分吸收各家所长,设计研发出具有德思宏特色优势的液压增压器,既大幅度降低了液压增压器的生产成本,同时性能也得到了很大的提升。公司产品有单作用往复增压器、双作用往复增压器、管式液压增压器、法兰式液压增压器、叠加式液压增压器,液压增压集成阀块,超高压液压系统,超高压动力单元,超高压过滤器,超高压充液卸荷阀等。公司拥有全套生产设备,生产周期短,成本低,质量有保障,同时拥有过硬的技术能力。围绕液压增压器,德思宏还能根据不同行业提供专业的超高压方案并设计制造相应的专用液压系统。公司集设计研发-生产销售-安装-维护一站式服务,售后有保障。现公司产品广泛应用于工程机械、救援设备、模内热切、机床设备、测试行业、风电新能源,航空,石油化工、液压工具、以及注塑、锻压等行业及其设备中!



company introduces

NingBo Desihom Hydraulic Technology Co.,LTD,which is the manufacturer professional engaged in design, research and manufacture of hydraulic boosters. Our research launched in 2007, on the basis of fully absorbing international and domestic advanced booster technology, Desihom designed products with its own characteristics.reduces the costs and improve the performance.

Desihom's product primarily in the area of boost, Now we manufacture a variety of models of integrated hydraulic boosters, Threaded mounting, Flange mounting, Stacking manifold mounting. automation pressure cylinders. Integrated booster, High pressure unit, High pressure system, High pressure filter, High pressure unloading valve, etc.

Desihom company has a full set of production equipment, production cycle is short, low cost, quality assurance; At the same time have excellent technical ability.

Around the hydraulic booster, Desihom offer professional solutions of ultra-high pressure for different industries, and design and manufacture special hydraulic system accordingly. Desihom company set design r & d - sales - production - installation - maintenance one-stop service, after-sales guarantee.

Now our products are widely used in engineering machinery, ship building, wind power, new energy, aerospace, petroleum machinery, hydraulic tools, as well as injection molding, forging industry and other equipment.

目录 CONTENTS

1 介绍 INTRODUCTION

A ▶ 工作原理 Principle

B ▶ 为什么使用增压器 Why use it

C ▶ 应用 Application

2 液压增压器 BOOSTER

D ▶ T系列增压器 T series booster

E ▶ M系列增压器 M series booster

F ▶ L系列增压器 L series booster

H ▶ X系列增压器 X series booster

3 系统集成 INTEGRATION

I ▶ 增压集成 Integrated booster

J ▶ 动力单元 High pressure unit

K ▶ 高压系统 High pressure system

4 附件 ACCESSORIES

L ▶ 超高压卸荷阀 Unloading valve

M ▶ 超高压过滤器 Filter

N ▶ 连接件 Connector

O ▶ 针阀 Needle valves

P ▶ 超高压软管 Hose

Q ▶ 超高压快速接头 Couplings

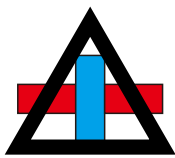

不断创新

追求卓越

Constant innovation, Striving for excellence

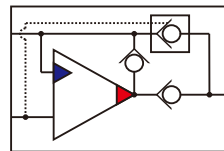

介绍

工作原理

液压增压器本质上就是自动化增压缸。

由于低压大活塞LP的面积大于高压小活塞HP的面积，低压压力将推动低压大活塞LP向上运动并压缩高压小活塞HP端的液柱，产生高压，大小活塞面积比即为增压器的增压比。通过小活塞HP位置反馈控制液控换向阀自动换向，实现大小活塞往复运动，连续增压。

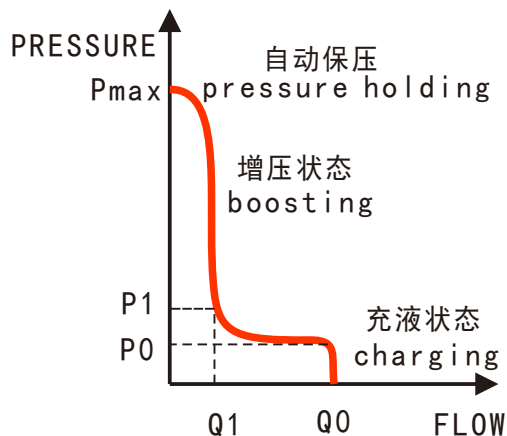
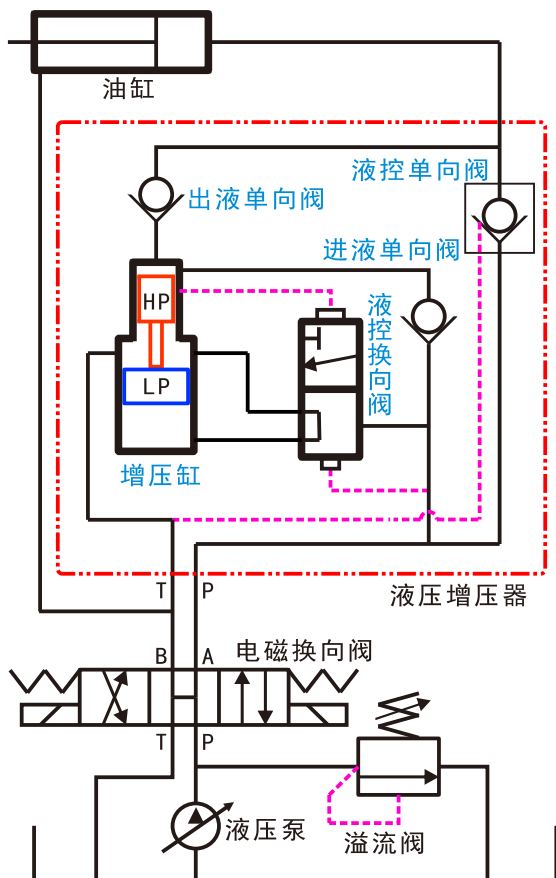

低压充液：液压油从P口进入增压器，大部分通过液控单向阀直接到油缸无杆腔；其余通过进液单向阀、出液单向阀到达油缸无杆腔，实现快速供油。

增压阶段：液控单向阀因压力平衡自动关闭，液压油通过进液单向阀到达活塞HP顶端，推动增压缸活塞LP一起下移到底部。活塞HP到底部后，高压油将与增压器换向阀芯上部接通，推动阀芯向下运动。换向后，液压油通过增压器换向阀达到活塞LP底部，推动活塞HP向上运动，输出高压油，通过出液单向阀到达油缸无杆腔；活塞HP到顶部后，增压器换向阀顶部与增压器T口连接，换向阀再次换向，回到图示初始位置。如此自动循环，增压器可以实现高频动作并连续输出高压油。

自动保压：高压端压力使高压活塞HP与低压活塞LP达到力学平衡后，活塞将停止动作。当高压侧因负载减小或者泄漏等因素造成压力降低时，高低压活塞将失去力学平衡而自动循环补压。

卸荷功能：电磁换向阀换向，增压器T口的进油将打开液控单向阀，油缸无杆腔的液压油通过液控单向阀流回增压器P口，再通过电磁换向阀回到系统油箱。

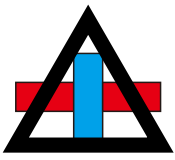

专注于液压增压器的研发

Focus on the research of hydraulic booster

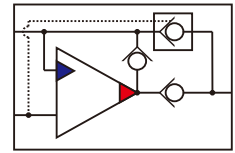

INTRODUCTION

HOW BOOSTER WORKS:

Hydraulic booster is based on an auto pressure cylinder.

A larger piston LP push a smaller piston LP up, thus increasing the pressure at the head of piston HP to a factor equal to the ratio of area between piston LP and piston HP, we use "I" represent the ratio.

QUICK SUPPLY: The low pressure fluid run into hydraulic booster from port P, through dump valve, most of them reach the hydro-cylinder, the others reach the hydro-cylinder through in valve and out valve, all the fluid quick supply into hydro-cylinder.

BOOSTING: As the hydro-cylinder meets resistance, the dump valve closed, the low pressure fluid reach the head of piston HP, push the piston HP and LP down. when the piston LP reach the bottom, the low pressure fluid reach the top of auto-direction valve and push it down. After reversing, through auto-direction valve the low pressure fluid reach the bottom of piston LP, push the piston HP up. In the process of moving, the generator generate a continuous high pressure fluid delivering to the hydro-cylinder. when the piston HP reach the top, the top of auto-direction valve connect to port T and the low pressure fluid push it up. After another reversing, return to initial location. as the cycle repeats, the booster output a continuous high pressure fluid with a high-frequency oscillation which can reach 2000 times per minute.

COMPENSATING: The cycle repeat until the high pressure at the head of piston H meet the requirement. At that point the booster stops and will only start again to maintain the pressure.

UNLOADING: As the direction valve reverse, the low pressure of the system run into port T, open the dump valve, the high pressure of the hydro-cylinder being relieved to port P, and then back to the tank.

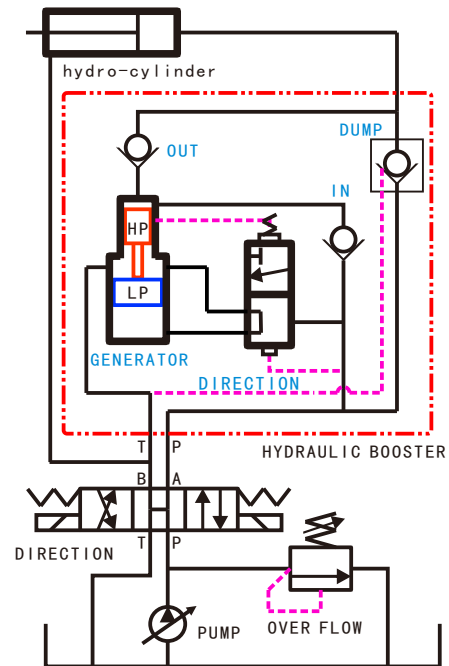

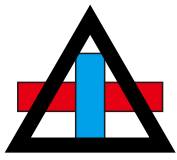

不断创新

追求卓越

Constant innovation, Striving for excellence

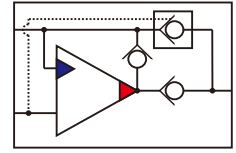

为什么使用液压增压器：

WHY USE THE BOOSTER:

在常见液压系统中，因负载在设计轻量化、安装空间受限制等方面的原因，油缸所需要的工作压力往往会不一致，原始方案是用不同压力等级的液压油泵组成泵组来实现，低压泵实现负载油缸快进快退，高压泵提供小流量液压油驱动负载最后阶段的动作。在系统元器件选型时，都必需按最高压力来进行元器件选配，造价方面居高不下；另外从安全方面考虑，系统总体油路承受的压力越高，其安全性就越低，系统因泄漏产生的发热量也会越大，元件故障率会比低压系统高出很多。

In the common hydraulic system, due to the limited weight of equipment, limited space of installation and other reasons, the hydro-cylinder work in different pressure frequently, the original scheme is use a low and high pressure pump set system, the low pressure pump drive hydro-cylinder fast movement, and the high pressure pump provide greater force. However, in that system, all the hydraulic components must be satisfied the high pressure capacity, so it will be cause high costs, more inner leakage and low security.

德思宏液压增压器在设计上完美地解决了以上的问题，将高压系统与低压系统完全地分开，低压的液压油通过增压器的自运循环增压后，直接进入高压负载，无需任何其它的高压控制元件，大大地降低了系统成本，提高了安全性，减少了系统的能量消耗，是最理想的液压高压乃至超高压解决方案。

Desihom hydraulic booster provide a perfect solution, separate the high pressure and low pressure completely. The hydraulic booster automatically boost the low pressure to higher pressure and then output directly to hydro-cylinder. without any other high pressure components, greatly reducing system costs, also improve safety.

适用工况APPLICABLE:

1、局部高压系统。

High pressure requirement in part of the system.

2、整体高压系统。

High pressure system.

3、静压高压系统。

Static pressure system.

* 液压增压器是任何实际应用领域最紧凑、最轻便的解决方案。

The hydraulic booster is the smallest and lightest solution in any high pressure industry.

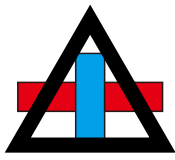

专注于液压增压器的研发

Focus on the research of hydraulic booster

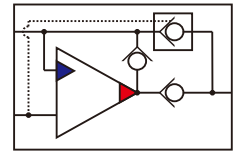

应用案例 APPLICATIONS:

模具合模

Mould Clamping



压滤机

Filter press machine



硫化机

Vulcanizing machine



连续挤压机

Continuous extruder



装载机

Loaders



自卸车

Dump truck



挖墙机

Wall grab crane



粉碎钳

Crushing forceps



消防救援

Fire rescue vehicle



救援机器人

Rescue robot



液压叉车

Hydraulic forklift



高空作业车

Aerial operating truck



顶管机

Pipe jacking



锚杆钻车

Rock bolting rigs



压铸机

Die-casting machines



支护顶升

Support jacking



翻车机



液压测试台



机床夹具



模内切系统



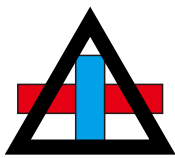

不断创新

追求卓越

Constant innovation, Striving for excellence

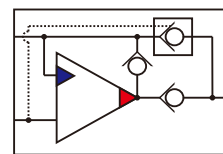

应用案例 APPLICATIONS:

折弯机

Bender machine



裁剪机

Cutting machine



冲孔机

Punching machine



油压机

Hydraulic press



液压压线钳

Hydraulic line presser



液压剪

Hydraulic shears



扩张钳

Expanding pliers



液压扳手

Hydraulic wrench



锚索张拉

Cable tensioners



螺栓拉伸器

Bolt Tensioners



劈裂枪

Cleavage gun



液压拉马

Hydraulic puller



顶升油缸

Jacking cylinder



液压弯管机

Hydraulic pipe bender



铁轨拉伸

Tracks stretching

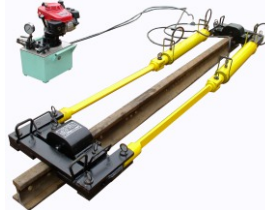

液压动力单元

Hydraulic power unit



铁钻工

Iron Driller



水下机器人

Unmanned Submarines



等静压机

Static Press

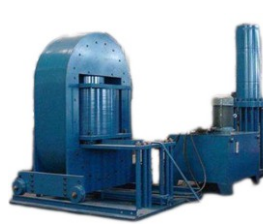

金刚石压机

Diamond press



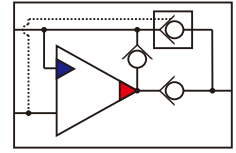
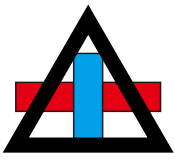

典型案例解析 Analysis of typical cases

一、模具合模应用 Mould Clamping

注塑机、压铸机等设备在作业时，常用高低压泵组方案，要求主系统压力等级按最高压力设计。一方面，因主系统压力余量大，在性能上造成了很大的浪费；另一方面，系统工作压力越高，其故障率也会越高，用户使用中的维修工作也就越多，增加了使用成本。德思宏液压增压器在设计上非常完美地解决了这些问题。我们可以在模具开合油缸的入口加装大流量的液控单向阀，将液压增压器与该单向阀并联。当油缸快速动作时，大流量液压油可以通过液控单向阀而不影响其动作性能。油缸到位后，低压油经过增压器后转换成高压油输入油缸，实现锁模功能。当油缸内压力达到设定值后，增压器将自动停止工作，因泄漏造成的压力下降，会由增压器自动补压以维持锁模力不变。

During the operation of injection molding machines, die-casting machines and other equipment, high and low pressure pump sets are commonly used, and the pressure level of the main system is required to be designed according to the highest pressure. On the one hand, due to the high pressure margin of the main system, a great waste of performance is caused. On the other hand, the higher the system pressure is, the higher failure rate will be, and the more maintenance work there will be, and increasing the cost. The Desihom hydraulic booster perfectly solves these problems in design. We can add a high flow pilot-operated check valve at the inlet of clamping cylinder, and parallel connect the Desihom hydraulic booster. When the cylinder moves quickly, the hydraulic oil can pass through the high flow pilot-operated check valve without affecting its performance. When the cylinder is in place, Desihom hydraulic booster boost the low pressure oil to higher one and input to the cylinder, then achieved mould clamping. When the pressure in the cylinder reaches the set value, the booster will stop working automatically. The pressure will drop due to leakage and the booster will compensate pressure automatically to maintain the clamping force.

二、机床夹具应用 Machine Fixture

随机床自动化技术的普及，液压夹具使用越来越广泛。使用液压增压器的机床夹具，可以在无须加装高压泵的情况下得到液压高压。我们可以将增压器与夹具做成一个集合体，夹具直接使用机床主液压系统3-6MPa的液压油。因夹具在快速动作方面不会有太大的流量需求，所以无需增压保护回路，只要在增压器P口加装精密过滤器即可达到其使用要求。系统中仅增压器一个高压部件，使用成本实现最小化，同时达到了最好的工作可靠性的最高的安全性。

With the popularization of automation machine fixture, hydraulic fixture are used more and more widely. The Desihom hydraulic booster can obtain high pressure

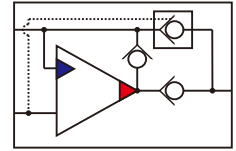
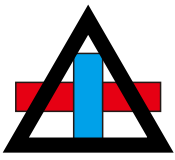

without use of the high pressure pump. Assemble Desihom hydraulic booster to the fixture, and then directly connect the hydraulic oil of 3-6MPa of the main hydraulic system of the machine to the fixture. The hydraulic fixture does not need too much flow, there is no need the protection loop, install a filter at the P port of the booster. In the system, there is only one high pressure component, which can minimize the cost and achieve the highest safety and the best working reliability.

三、液压工具应用 Hydraulic Tools

液压工具要求重量轻、体积小，方便携带，并且可靠性高，安全性高。

现用超高压泵直接提供超高压液压油，超高压泵现存在的问题有：

- 1、使用寿命短，一般可累计工作时间仅1000小时左右；
- 2、安全性不高，外接管路都是超高压软管，因频繁拖动容易造成安全隐串，超高压快插接头频繁使用后也是一个危险源；
- 3、成本高，系统里所有元器件，包括换向阀、过滤器、管路、压力表等都是超高压器件，造价是低压系统的3倍以上。

使用德思宏液压增压器，因增压器体积小，可以安装在液压工具上面，所有液压胶管、液压站等全部使用低压器件，可靠性更高、安全性更好、成本更低。因使用低压泵后发热量变小，体积可以做的更小，重量可以更轻。

Hydraulic tools require light weight, small size, easy to carry, and high reliability and safety. The existing ultra-high pressure hydraulic oil is directly provided by the ultra-high pressure pump. The existing problems of the ultra-high pressure pump are as follows:

- 1、Short service life, generally working time is only around 1000 hours;
- 2、The safety is not high, the external pipes are all ultra-high hoses, which is a potential risk due to frequent movement, and the ultra-high quick connector is also a risk factor;
- 3、High cost. All components in the system, including direction valve, filter, hoses and pressure gauge, are ultra-high pressure, and the cost is more than 3 times of that of low-pressure system.

Desihom hydraulic booster, with the small volume, can be installed at the end of the hydraulic tools, all hydraulic hoses, hydraulic system all use low-pressure components, higher reliability, better safety, lower cost, and volume will be smaller, weight will be lighter.

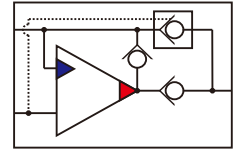
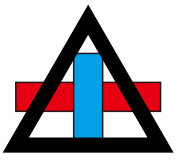

四、煤矿锚索作业 Coal Mine Anchor Cable Operation

煤矿锚索作业设备在功能上即是液压剪与拉伸器的组合，可分为锚索张拉机具及锚索剪切机具，配合矿用锚孔钻机作业。原传统方案都是用超高压手动泵提供液压超高压，每个作业面求要20人以上的班组才能作业。

使用德思宏液压增压器，可以从锚孔钻机底盘上直取16MPa的系统压力，输送给张拉、剪切作业的专用机械臂上的液压增压器，直接给机具输出超高压。因设备自动化程度高，作业面人员可降到10人以下，最大限度地提高了生产效率，降低了生产成本。

Coal mine anchor cable operation equipment is the combination of hydraulic shear and stretcher in function, which can be divided into anchor cable tensioning machine and anchor cable shearing machine, cooperating with mine anchor hole drilling machine. The traditional scheme is to use ultra-high pressure manual pump to provide hydraulic ultra-high pressure, each operating point requires more than 20 people.

The system pressure of 16 MPa can be directly taken from the chassis of the anchor hole drilling machine by using the Desihom hydraulic booster, which is transported to the hydraulic booster on the special mechanical arm for tension and shearing operation, and the super high pressure can be output directly to the machine tool. Because of the high degree of automation of the equipment, the operating point personnel can be reduced to less than 10 people, maximizing the production efficiency and reducing the production cost.

五、石油钻机-铁钻工应用 Iron Driller

铁钻工作为钻杆夹持机具，要求动作快、效率高，可靠性高。原方案使用高压泵，系统元器件均采购高压配置，系统发热量大，安全性低，成本高。使用德思宏液压增压器后，无需再加装高压泵，而且是瞬间发生高压，能以最小的能量消耗、最低的制做成本来达到使用要求，并且适合高频率的动作使用，提高其工作效率。目前使用液压增压器到铁钻工的公司有：上海国民油井、武汉江汉石油、宝鸡石油机械等。

The drill pipe clamping device, which requires fast action, high efficiency and high reliability. The original scheme uses high-pressure pump, system components are purchased high-pressure configuration, system heat, low security, high cost. After using the Desihom hydraulic booster, no need to install a high pressure pump, and is instantaneous high-pressure, with the smallest energy consumption, the lowest manufacturing cost to meet the use requirements, and suitable for high-frequency operation, improve its efficiency. At present, the use of hydraulic booster to iron drilling companies are: Shanghai National Oil Well, Wuhan Jiangnan Oil, Baoji Oil Machinery and so on.

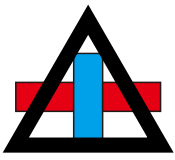

不断创新

追求卓越

Constant innovation, Striving for excellence

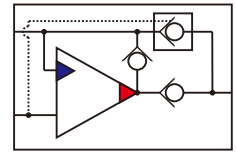

六、矿山应用 Mining Equipment

液压劈裂机是矿山应用的典型。液压劈裂机通过70-120Mpa的液压超高压驱动劈裂枪，将大的石料整体劈裂，其设备应用方面有高污染、少保养等特点，超高压泵头在这种作业环境下使用寿命约3个月。通过使用德思宏液压增压器，我们可以设计更适合这种工况的系统，达到更长的使用寿命，并且提高工作效率、减少设备能耗。

Hydraulic splitter is a typical example of mining equipment. Hydraulic splitter splits large stone entirely through 70-120 Mpa hydraulic ultra-high pressure driving splitting gun. Its equipment has the characteristics of high pollution and less maintenance. The service life of ultra-high pressure pump is about 3 months in this operating environment. By using the Desihom hydraulic booster, we can design a system more suitable for this kind of working condition, achieve longer service life, and improve work efficiency, reduce equipment energy consumption.

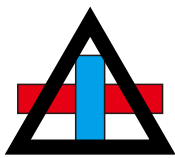

专注于液压增压器的研发

Focus on the research of hydraulic booster

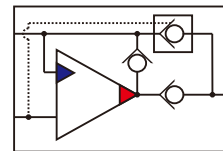

液压增压器选型

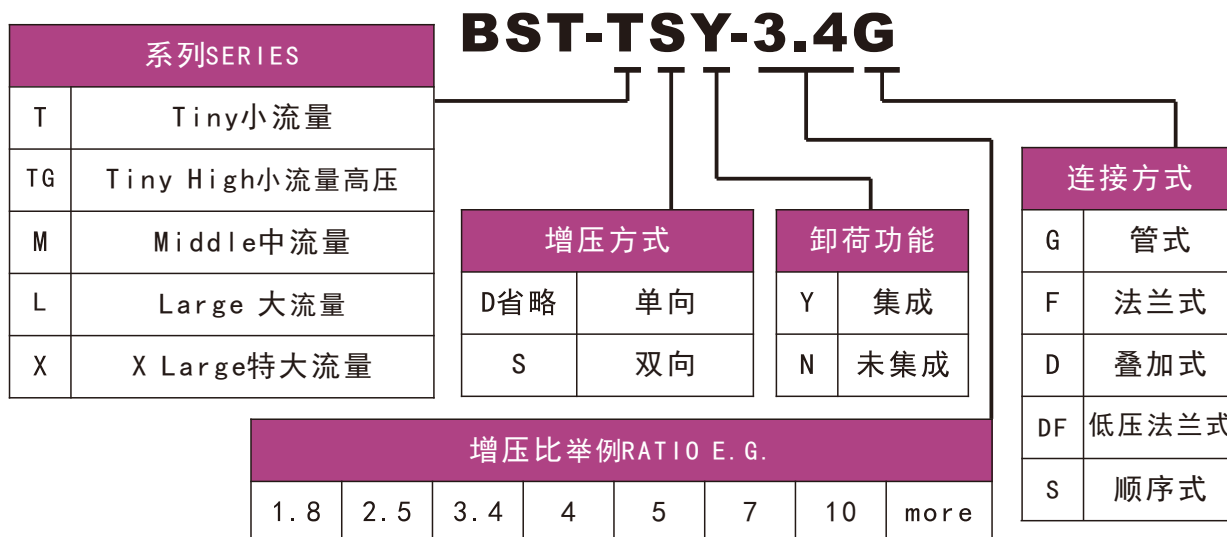

型号说明SELECTION METHOD

一、型号TYPE

BST:表示BOOSTER, 中文增压的意思。It means Booster

二、系列SERIES

T :tiny 微小的,表示小流量系列,输入流量最大约15L/min;

M :middle中等的,表示中流量系列,输入流量最大约35L/min;

L :Large大的,表示大流量系列,输入流量最大约100L/min;

X :X large,表示特别大的,输入流量最大约200L/min。

三、增压方式ACTING MODE

D :表示单向连续增压;代号D可以省略。Single-acting, "D" can be omitted

S :表示双向连续增压。Dual-acting

四、卸荷功能UNLOADING FUNCTION

Y :表示集成了卸荷功能(默认为集成卸荷功能);Integrated

N :表示不带卸荷功能。Not Integrated

五、增压比举例RATIO E. G.

输出压力与输入压力的比值,例如:1.8倍,2.5倍,3.4倍,4倍,5倍,7倍,10倍。

The ratio of output pressure to input pressure. e. g. 2.5, 3.4, 4, 5, 7, 10.

六、连接方式MOUNTING MODE

G :P、T进出口和HP高压输出口为螺纹式连接; Threaded mounting

F :P、T进出口和HP高压输出口为法兰式连接; Flange mounting

D :P、T进出口和HP高压输出口为叠加式连接; Stacking manifold

R :可旋转式输出口连接(可根据要求定做)。Rotary mounting(customized made)

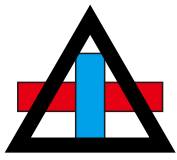

不断创新

追求卓越

Constant innovation, Striving for excellence

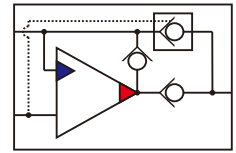

选型方法SELECTION METHOD:

1、根据低压输入流量选择增压器系列；

Select the booster series according to low pressure input flow.

2、根据低压输入压力和高压输出压力选择增压比例；

Select the booster ratio according to the output pressure and input pressure

3、根据系统布管要求选择连接方式；

Select the mounting mode according to the requirements of system layout.

4、其他要求。Other requirements

选型实例EXAMPLE:

现有一高压油缸需要60Mpa的超高压，所需超高压流量为1-1.5升每分钟，低压输入压力为0-25Mpa可调。

One high-pressure cylinder requires 60 Mpa of ultra-high pressure, required ultra-high pressure flow rate of 1-1.5 litres per minute, input pressure of 0-25 Mpa adjustable.

增压器选配步骤如下：The selection steps are as follows:

第一步：选定增压比。与参数表核对，T系列小流量3.4倍增压比输出压力值与该需求相近，暂定增压比为3.4倍；

Step one: select the booster ratio. Check parameter table, The booster which boost ratio of 3.4 of T series is similar to the demand, Temporary select ratio of 3.4.

第二步：校核输出流量。T系列小流量3.4倍增压比的最大流量为2.7升每分钟，高压输出流量为1.2升每分钟，基本符合要求；

The second step: Check output flow. The maximum flow of T series rate of 3.4 is 2.7 L/min, and we need the high-pressure output flow rate is 1.2 L/min, so it meets the requirements;

第三步：校核输入压力。该增压比达到60Mpa所需的输入压力值为 $60/3.4=17.65$ Mpa, 此时低压泵工作在高效率区间，压力适中；

The third step: Check the input pressure. The input pressure required for the boost ratio to reach 60 Mpa is $60/3.4 = 17.65$ Mpa, this pressure is in the high efficiency range of the pump.

第四步：选定型号。根据以上推断，可选定型号为BST-TY-3.4G, 系统设计时注意连接接头为G1/4。

The fourth step: Confirm the selection model. According to the above inference, the optional model is BST-TY-3.4G, the system design should pay attention to the connection of G1/4.



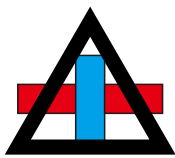

专注于液压增压器的研发

Focus on the research of hydraulic booster

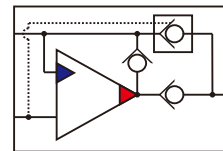

T系列管式 T Series Threaded Mounting



参数表

PARAMETER TABLE

增压比 RATIO	额定输入流量 INPUT LPM	临界输出流量 OUTPUT LPM	额定输入压力 INPUT BAR	额定输出压力 OUTPUT BAR	额定频率 FREQUENCY
1.8	16	4.6	250	450	1960
2.5	15	3.45	250	625	2020
3.4	15	2.70	250	850	2160
4.0	14	2.17	250	1000	2100
5.0	14	1.8	200	1000	2190
7.0	13	1.23	144	1000	2120
10.0	8	0.55	100	1000	1360

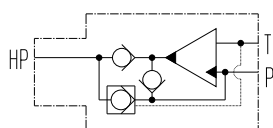

管式安装尺寸

Dimensions of Threaded Mounting

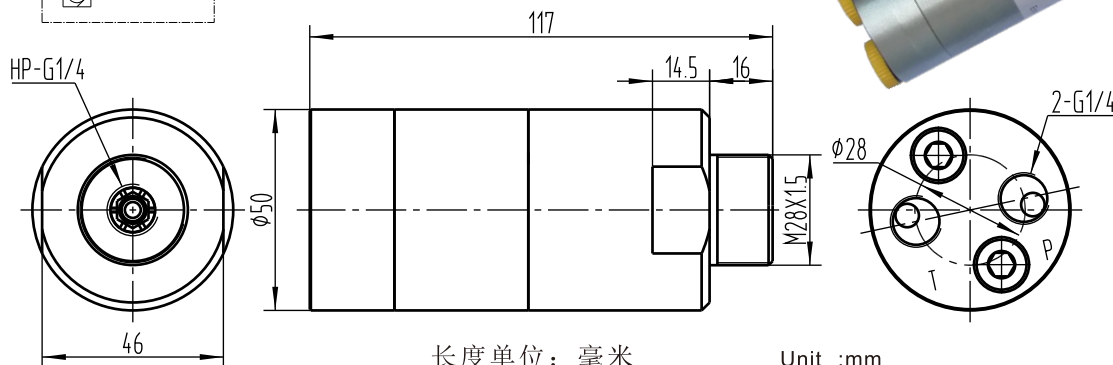

长度单位: 毫米 Unit :mm
 重量: 1.5公斤 Weight: 1.5KG
 其他: 可以和锁紧螺母或安装板连接
 Others: It can be connected to the locknut or mounting plate.

T小流量系列增压器以其方便灵活的安装方式, 非常广泛地应用于各个行业产品的高压发生部分, 用单一的增压元件替代了由高压泵、高压管路、高压控制件等组成的高压系统, 为产品最大限度地降低了制做成本, 提高了产品的可靠性、安全性。

T series booster is widely used in the high pressure parts of various industries because of its convenient and flexible mounting. It replaces the high pressure system composed of high pressure pump, high pressure pipeline and high pressure control components, thus lowering the manufacturing cost and improving reliability and safety of the products.

选型示例: BST-TN-4.0G T系列增压器, 不带卸荷功能, 4倍率增压比, 管式连接

Example: BST-TN-4.0G T series, no unloading function, intensification factors is 4, threaded mounting.

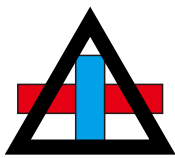

不断创新

追求卓越

Constant innovation, Striving for excellence

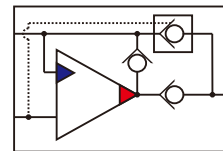

T系列法兰式 T Series Flange Mounting

参数表

PARAMETER TABLE

增压比 RATIO	额定输入流量 INPUT LPM	临界输出流量 OUTPUT LPM	额定输入压力 INPUT BAR	额定输出压力 OUTPUT BAR	额定频率 FREQUENCY
1.8	16	4.6	250	450	1960
2.5	15	3.45	250	625	2020
3.4	15	2.70	250	850	2160
4.0	14	2.17	250	1000	2100
5.0	14	1.8	250	1250	2190
7.0	13	1.23	250	1750	2120
10.0	8	0.55	200	2000	1360

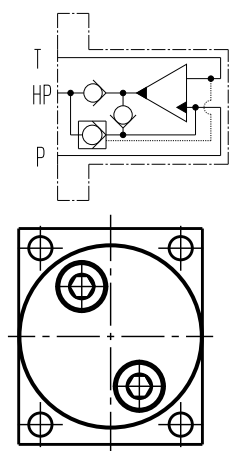

法兰式安装尺寸 Dimensions of Flange Mounting

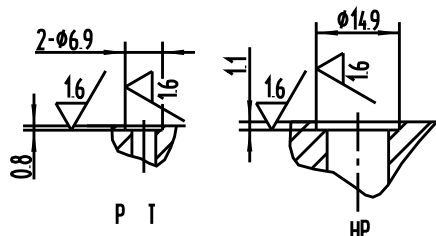
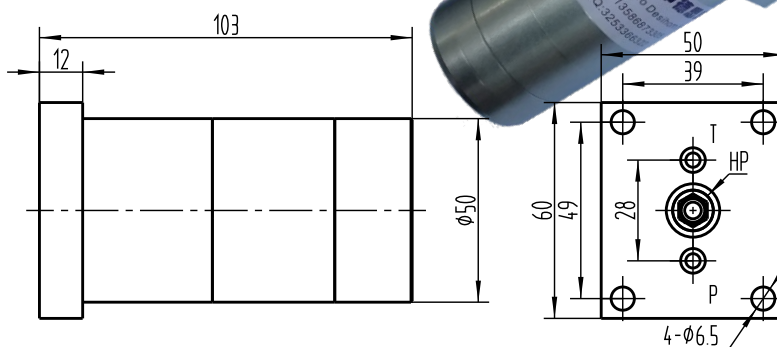

长度单位: 毫米 Unit :mm
重量: 1.5公斤 Weight: 1.6KG
连接要求: 连接面粗超度0.8, P、T孔小于4mm
Others: Required surface finish Ra0.8, P、T holes less than 4mm

注意: P、T口连接孔不得大于4mm, HP口不得大于10mm.
NOTE: P&T connect hole ≤ 4mm, HP ≤ 10mm.

选型示例: BST-TY-1.8F T系列增压器, 带卸荷功能, 1.8倍率增压比, 法兰式连接

BST-TN-10F T系列增压器, 不带卸荷功能, 10倍率增压比, 法兰式连接

Example: BST-TY-1.8F T series, with unloading function, intensification factors is 1.8, flange mounting.

BST-TN-10F T series, no unloading function, intensification factors is 10, flange mounting.

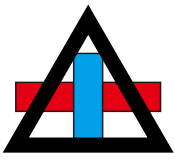

专注于液压增压器的研发

Focus on the research of hydraulic booster

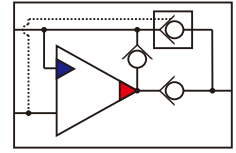

T系列叠加式 T Series Stacking Manifold

参数表同管式(略)

PARAMETER TABLE Same as Threaded Mounting

叠加式安装尺寸

Dimensions of Stacking Manifold

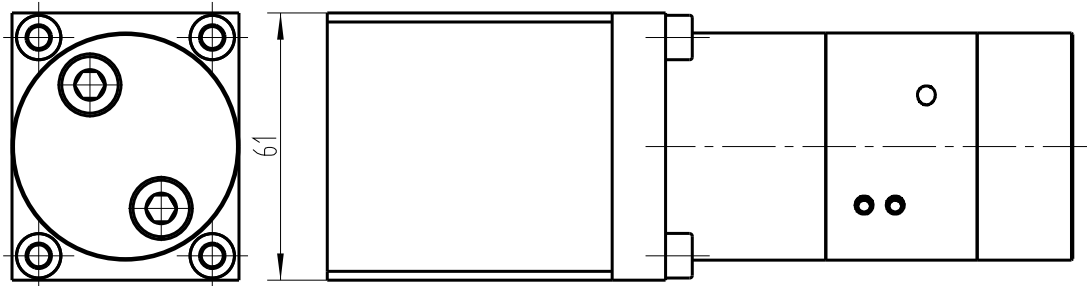
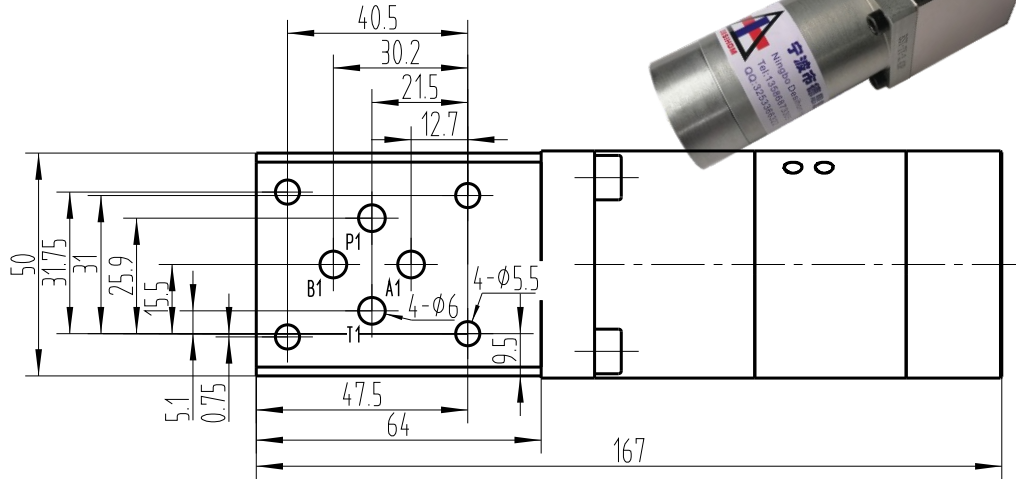
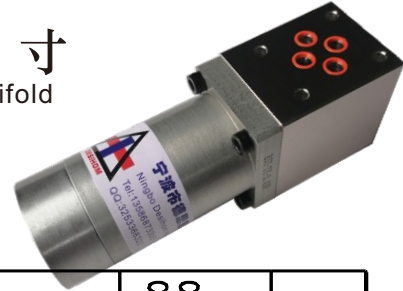

长度单位: 毫米

Unit :mm

重量: 3.2公斤

Weight: 3.2KG

注意: 连接孔不得大于6mm

NOTE: connect hole ≤ 6mm

油路符号

Oil Channels

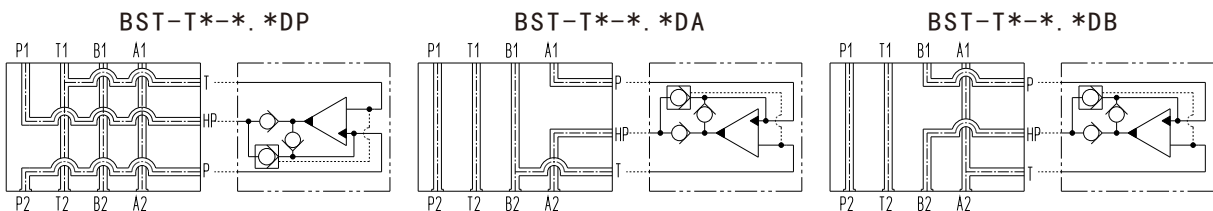

选型示例: BST-TY-1.8DP T系列增压器, 带卸荷功能, 1.8倍率增压比, 叠加式连接, P增压

BST-TN-4.0DA T系列增压器, 不带卸荷功能, 4倍率增压比, 叠加式连接, A增压

Example: BST-TY-1.8DP T series, with unloading function, intensification factors is 1.8, Stacking Manifold, P boost

BST-TN-4.0DA T series, no unloading function, intensification factors is 4, Stacking Manifold, A boost

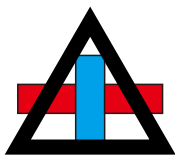

不断创新

追求卓越

Constant innovation, Striving for excellence

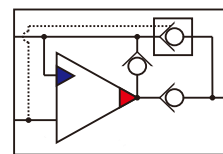

TG系列高压 TG Series High Pressure



参数表 PARAMETER TABLE

增压比 RATIO	额定输入流量 INPUT LPM	临界输出流量 OUTPUT LPM	额定输入压力 INPUT BAR	额定输出压力 OUTPUT BAR	额定频率 FREQUENCY
7.0	13	1.23	250	1750	2120
10	8	0.55	200	2000	1360

安装尺寸 Dimensions

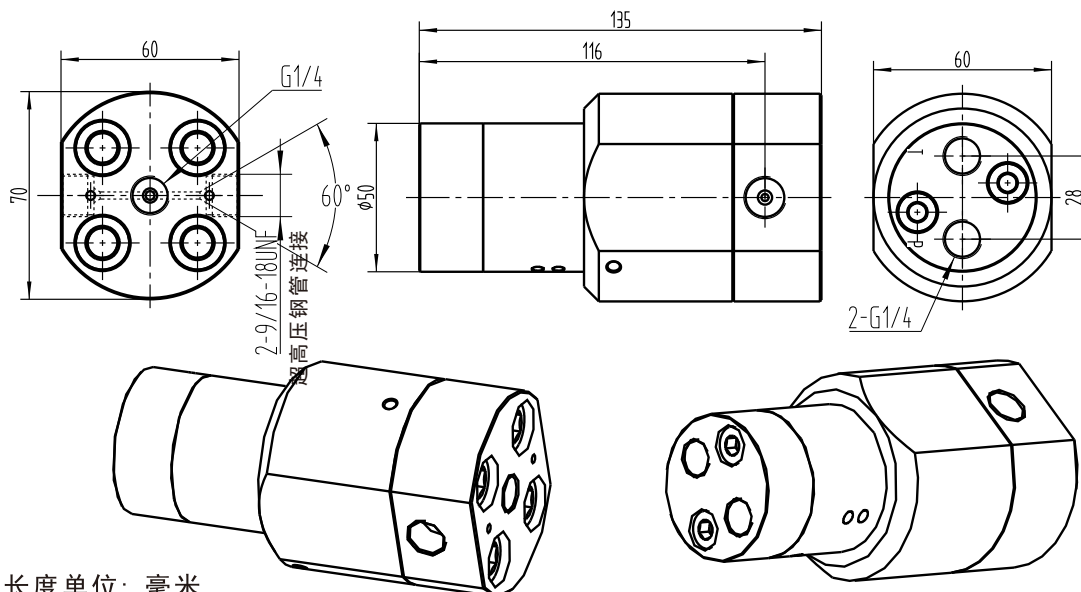

长度单位: 毫米

重量: 2.8公斤

安装方式: 低压管式连接G1/4, 高压9/16-18UNF和G1/4螺纹连接

其他: 可以和安装板连接

Unit :mm

Weight: 2.8KG

Mounting: Low pressure G1/4, high pressure 9/16-18UNF and G1/4 threaded connection.

Others: It can be connected to the mounting plate

TG小流量系列增压器能输出极高的压力, 适用于压力测试, 井口控制盘, 劈裂机等行业。

选型示例

BST-TGN-7.0G TG系列增压器, 不带卸荷功能, 7倍率增压比, 管式连接

BST-TGY-10G TG系列增压器, 带卸荷功能, 10倍率增压比, 管式连接

Example:

TG series booster can output extremely high pressure, suitable for pressure testing, wellhead control panel, splitter and other industries

BST-TGN-7.0G TG series booster, no unloading function, intensification factors is 7.0, threaded connection.

BST-TGY-10G TG series booster with unloading function, intensification factors is 10, threaded connection.

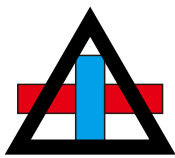

专注于液压增压器的研发

Focus on the research of hydraulic booster

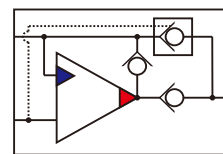

M系列管式 M Series Threaded Mounting



参数表

PARAMETER TABLE

增压比 RATIO	额定输入流量 INPUT LPM	临界输出流量 OUTPUT LPM	额定输入压力 INPUT BAR	额定输出压力 OUTPUT BAR	额定频率 FREQUENCY
1.9	35	10	250	475	1730
2.5	35	8.3	250	625	1880
3.4	35	6.4	250	850	2040
4.0	35	5.6	250	1000	2100
5.0	35	4.5	200	1000	2190
7.0	30	2.8	144	1000	1960
10.0	25	1.5	100	1000	1700

管式安装尺寸

Dimensions of Threaded Mounting

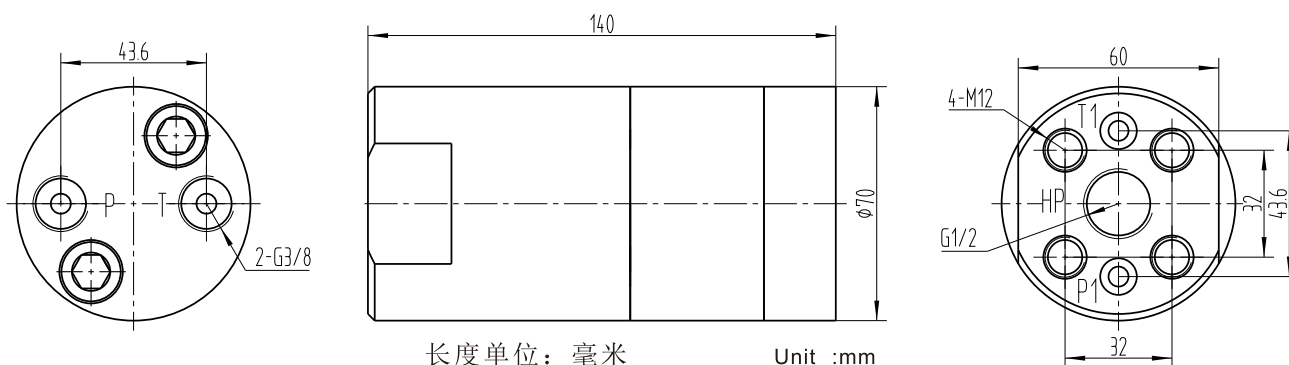

油路符号 Oil Channels

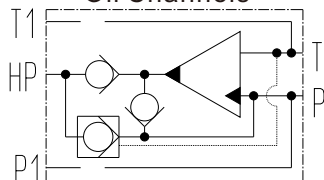

长度单位：毫米 Unit :mm
重量：3.4公斤 Weight: 3.4KG
其他：可以和安装板连接 Others:It can be connected to the mounting plate.

注意：默认T和T1不通，P和P1不通，可以根据要求打通。
Note: T and T1 didn't get through, P and P1 didn't get through.

M系列增压器输出流量大，非常适合快速合模，锁紧系统，工程夹具，矿山机械等的应用。

选型示例：BST-MY-1.9G M系列增压器，带卸荷功能，1.9增压比例，管式连接

M series booster with larger output flow is very suitable for rapid die fitting, locking system, engineering fixture, mining machinery and other applications.

Example: BST-MY-1.9G M series booster with unloading function, intensification factors is 1.9 and threaded connection.

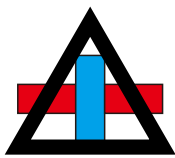

不断创新

追求卓越

Constant innovation, Striving for excellence

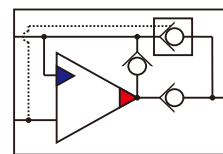

M系列法兰式 M Series Flange Mounting



参数表

PARAMETER TABLE

增压比 RATIO	额定输入流量 INPUT LPM	临界输出流量 OUTPUT LPM	额定输入压力 INPUT BAR	额定输出压力 OUTPUT BAR	额定频率 FREQUENCY
1.9	35	10	250	475	1730
2.5	35	8.3	250	625	1880
3.4	35	6.4	250	850	2040
4.0	35	5.6	250	1000	2100
5.0	35	4.5	250	1250	2190
7.0	30	2.8	250	1750	1960
10.0	25	1.5	250	2500	1700

法兰式安装尺寸

Dimensions of Flange Mounting

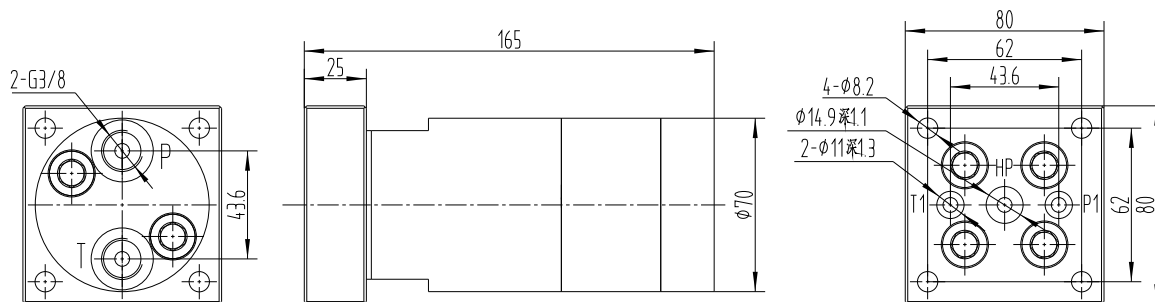

油路符号 Oil Channels

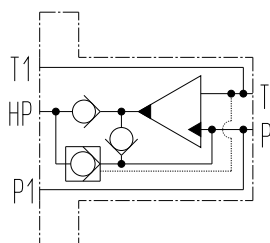

长度单位：毫米 Unit :mm
重量：4.4公斤 Weight: 4.4KG
其他：可以和安装板连接 Others: It can be connected to the mounting plate.

注意：默认T和P采用ED堵头堵上。
Note: T and P is plugged with ed plug.
P1, T1口连接孔不得大于6mm, HP口不得大于10mm.
NOTE: P1&T1 connect hole ≤6mm, HP≤10mm.

选型示例: BST-MY-1.9F M系列增压器, 带卸荷功能, 1.9增压比例, 法兰式连接

Example: BST-MY-1.9F M series booster with unloading function, intensification factors is 1.9 and Flange Mounting.

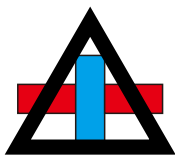

专注于液压增压器的研发

Focus on the research of hydraulic booster

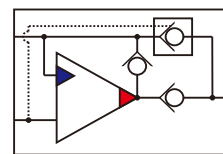

M系列叠加式 M Series Stacking Manifold

参数表同管式(略)
PARAMETER TABLE Same as Threaded Mounting

叠加式安装尺寸

Dimensions of Stacking Manifold

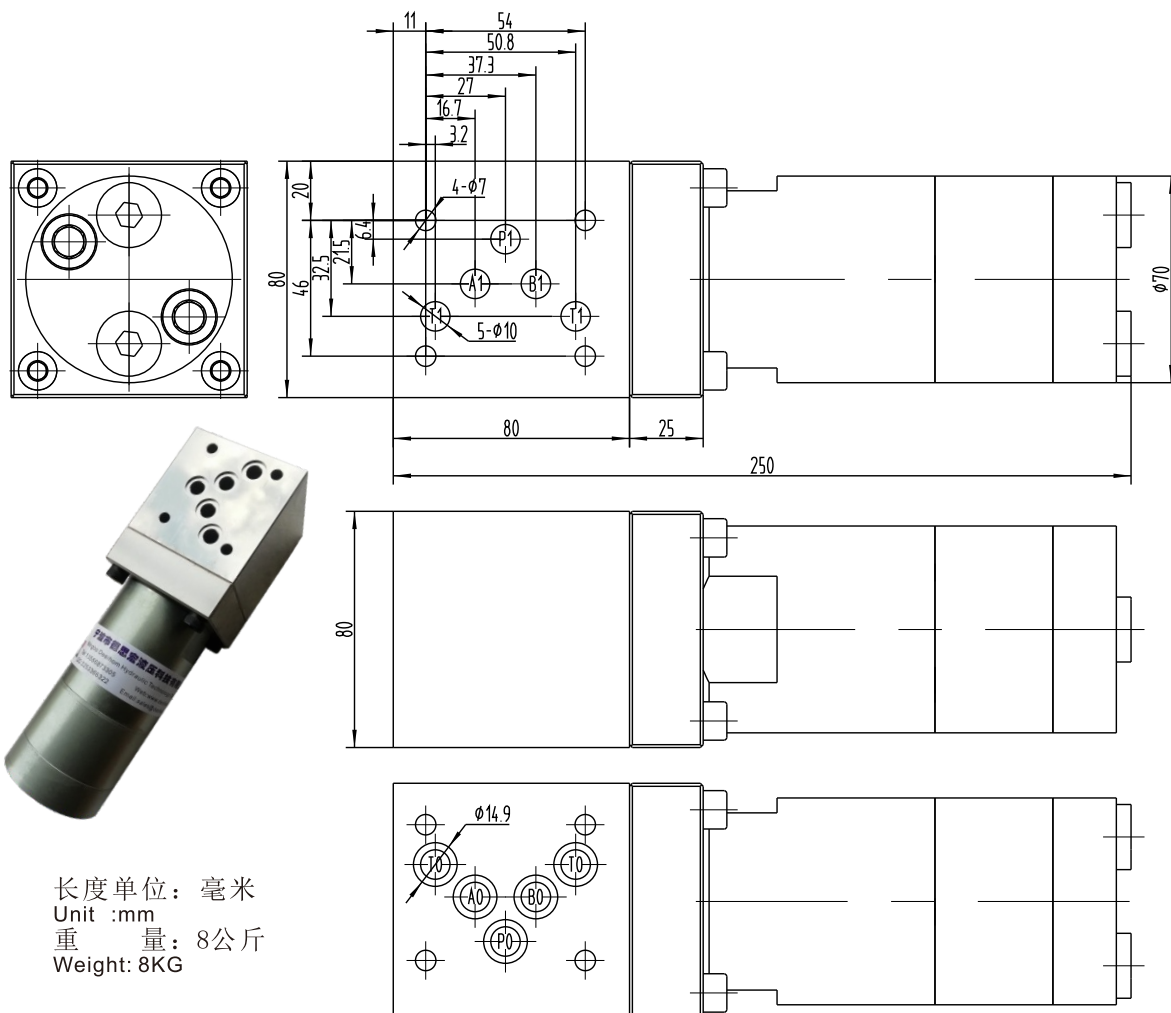

长度单位：毫米
Unit :mm
重量：8公斤
Weight: 8KG

注意：连接孔不得大于10mm
NOTE: connect hole ≤ 10mm

油路符号 Oil Channels

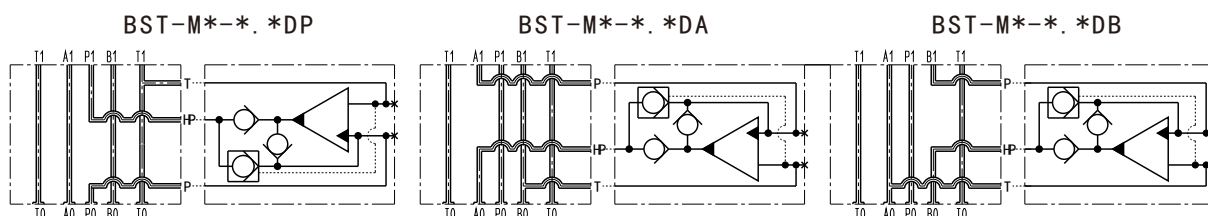

选型示例: BST-MY-1.9DB M系列增压器, 带卸荷功能, 1.9增压比例, 叠加式连接, B增压

Example: BST-MY-1.9DB M series, with unloading function, intensification factors is 1.9, Stacking Manifold, B boost

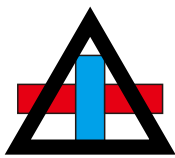

不断创新

追求卓越

Constant innovation, Striving for excellence

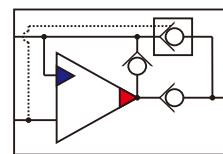

MG系列高压 MG Series High Pressure

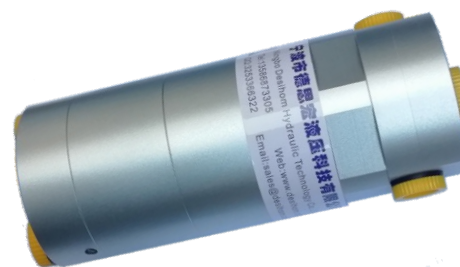

参数表

PARAMETER TABLE

增压比 RATIO	额定输入流量 INPUT LPM	临界输出流量 OUTPUT LPM	额定输入压力 INPUT BAR	额定输出压力 OUTPUT BAR	额定频率 FREQUENCY
7.0	30	3	200	1400	1980
10	30	2	200	2000	2060

安装尺寸

Dimensions

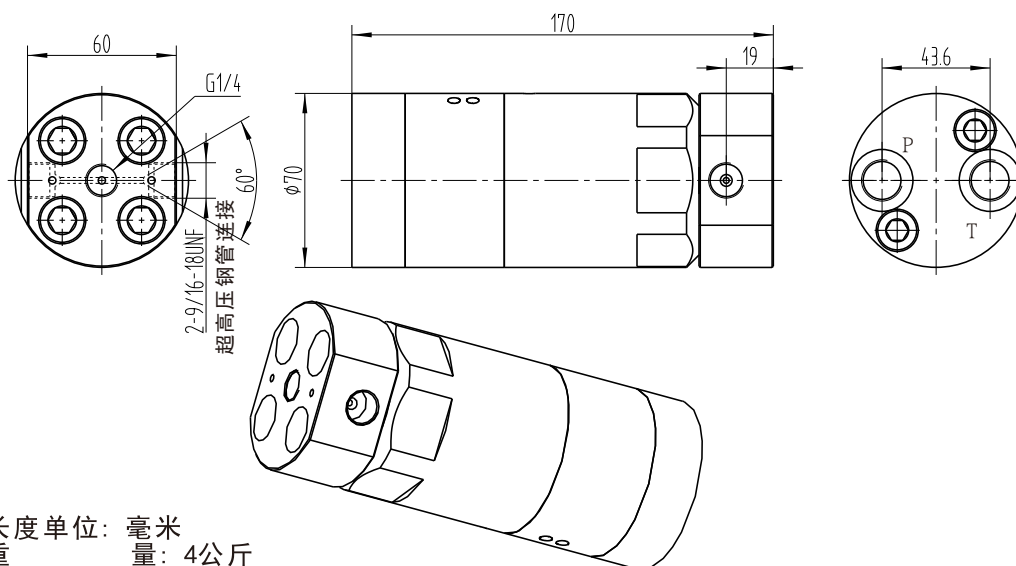

长度单位: 毫米

重量: 4公斤

安装方式: 低压管式连接G3/8, 高压9/16-18UNF和G1/4螺纹连接
其他: 可以和安装板连接

Unit :mm

Weight: 4KG

Mounting: Low pressure G3/8, high pressure 9/16-18UNF and G1/4 threaded connection.

Others: It can be connected to the mounting plate

MG中流量系列增压器能输出极高的压力, 适用于压力测试, 超高压泵站等行业。

选型示例:

BST-MGN-7.0G MG系列增压器, 不带卸荷功能, 7倍率增压比, 管式连接

BST-MGY-10G MG系列增压器, 带卸荷功能, 10倍率增压比, 管式连接

Example:

MG series booster can output extremely high pressure, suitable for pressure testing, ultra-high pressure pump station and other industries.

BST-MGN-7.0G MG series booster, no unloading function, intensification factors is 7.0, threaded connection

BST-MGY-10G MG series booster with unloading function, intensification factors is 10.0, threaded connection.

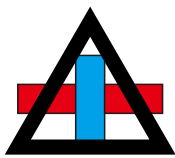

专注于液压增压器的研发

Focus on the research of hydraulic booster

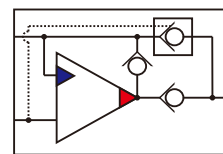

L系列管式 L Series Threaded Mounting

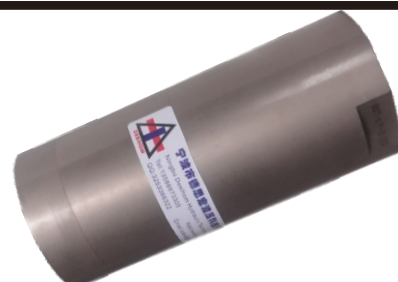

参数表

PARAMETER TABLE

增压比 RATIO	额定输入流量 INPUT LPM	临界输出流量 OUTPUT LPM	额定输入压力 INPUT BAR	额定输出压力 OUTPUT BAR	额定频率 FREQUENCY
1.4	100	38.5	250	350	635
2.0	100	30	250	500	727
3.2	100	21.6	250	800	820
4.5	100	16	222	1000	880
6.0	90	10.7	166	1000	833
8.0	80	7.3	125	1000	765
11	50	3.1	91	1000	493

管式安装尺寸

Dimensions of Threaded Mounting

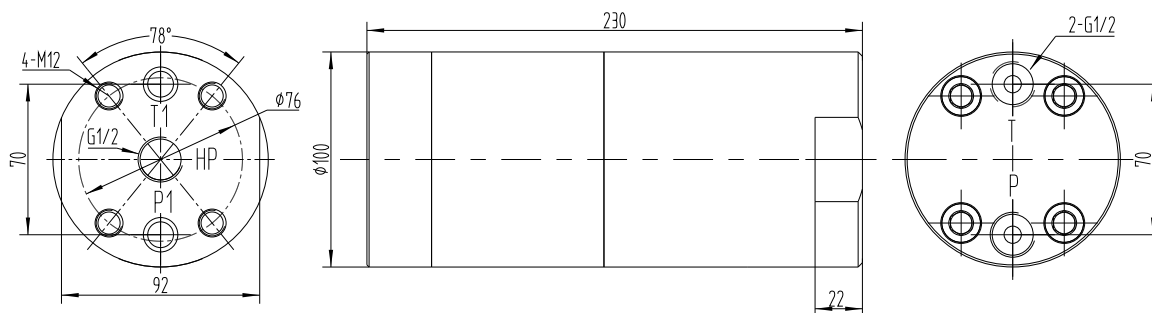

油路符号 Oil Channels

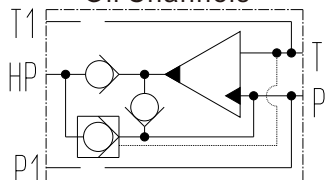

长度单位：毫米
重量：12公斤

Unit:mm
Weight: 12kg

注意：默认T和T1不通，P和P1不通，可以根据要求打通。

Note: T and T1 didn't get through, P and P1 didn't get through.

L系列增压器输出流量非常大，适合快速大型工程机械，矿山设备等的應用。

选型示例：BST-LY-2.0G L系列增压器，带卸荷功能，2.0增压比例，管式连接

L series booster with larger output flow is very suitable for engineering fixture, mining machinery and other applications.

Example: BST-LY-2.0G L series booster with unloading function, intensification factors is 2.0 and threaded connection.

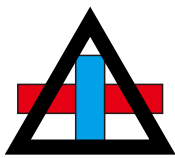

不断创新

追求卓越

Constant innovation, Striving for excellence

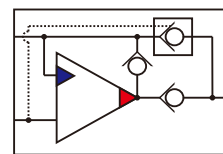

L系列法兰式 L Series Flange Mounting



参数表

PARAMETER TABLE

增压比 RATIO	额定输入流量 INPUT LPM	临界输出流量 OUTPUT LPM	额定输入压力 INPUT BAR	额定输出压力 OUTPUT BAR	额定频率 FREQUENCY
1.4	100	38.5	250	350	635
2.0	100	30	250	500	727
3.2	100	21.6	250	800	820
4.5	100	16	250	1125	880
6.0	90	10.7	250	1500	833
8.0	80	7.3	250	2000	765
11	50	3.1	250	2750	493

法兰式安装尺寸

Dimensions of Flange Mounting

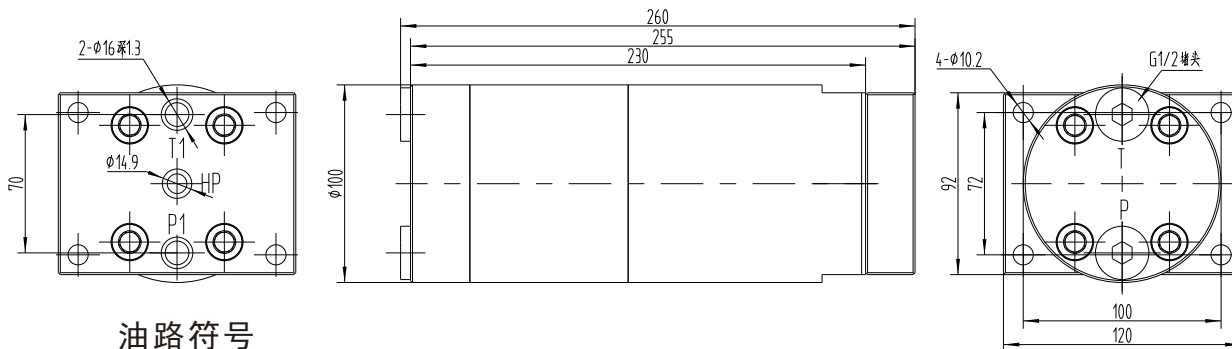

油路符号 Oil Channels

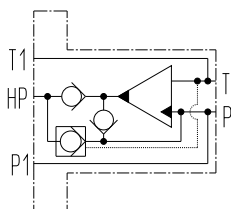

长度单位: 毫米
重量: 14公斤

Unit: mm
Weight: 14kg

注意: 默认T和P采用ED堵头堵上。
Note: T and P is plugged with ed plug .
P1, T1, HP口连接孔不得大于10mm.
NOTE: P1&T1&HP connect hole ≤10mm.

选型示例: BST-LY-8.0F L系列增压器, 带卸荷功能, 8.0增压比例, 法兰式连接

Example: BST-LY-8.0F L series booster with unloading function, intensification factors is 8.0 and Flange Mounting.

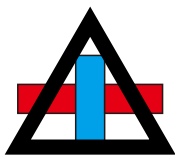

专注于液压增压器的研发

Focus on the research of hydraulic booster

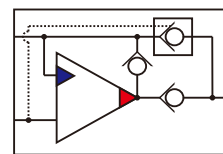

L系列低压法兰式 L Series LOW Flange

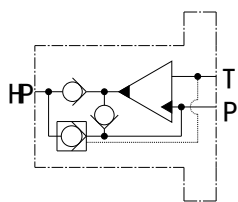

低压法兰式 安装尺寸 Dimensions of Low Flange Mounting

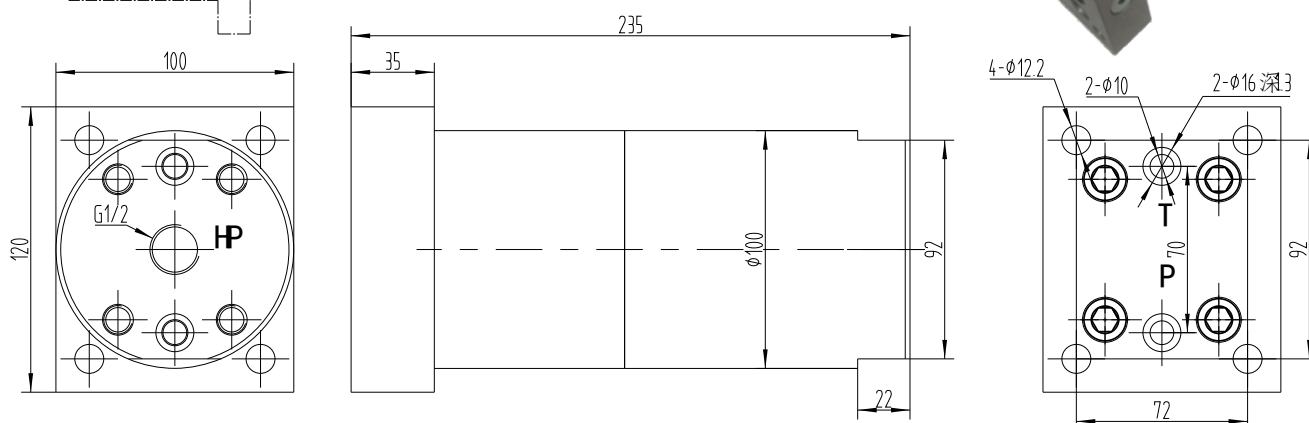

L系列顺序式 L Series Sequence Mounting

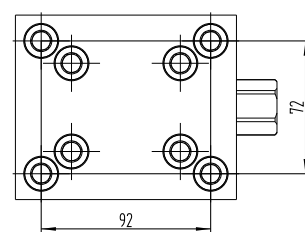
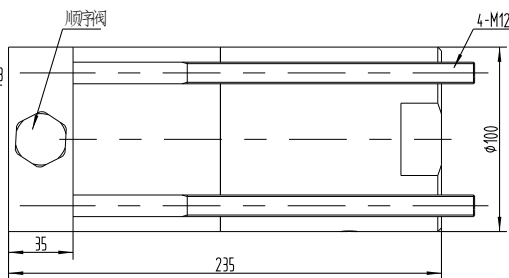
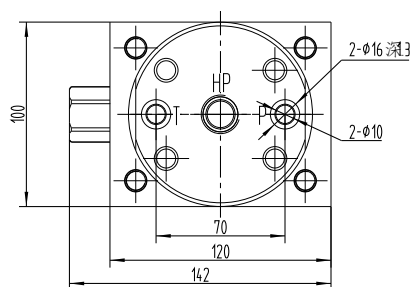
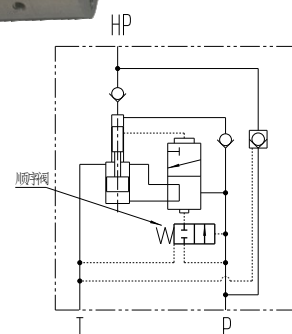
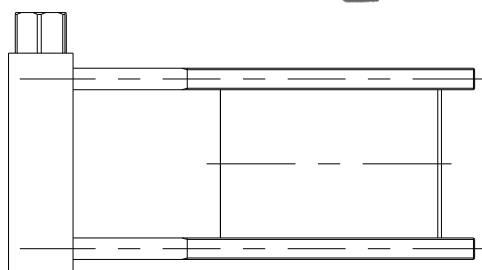
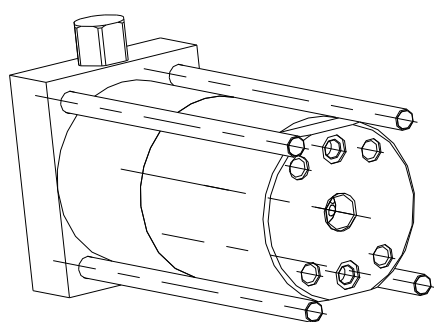

长度单位：毫米 Unit:mm
重 量：14公斤 Weight: 14kg

选型示例:BST-LY-8.0DF L系列增压器,带卸荷功能,8.0增压比例,低压法兰式连接

Example:BST-LY-8.0F L series booster with unloading function, intensification factors is 8.0 and Low FlangeMounting.

BST-LY-2.0S L系列增压器,带卸荷功能,2.0增压比例,顺序式连接

BST-LY-2.0S L series booster with unloading function, intensification factors is 2.0 and sequence

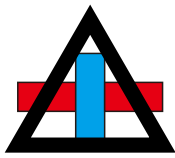

不断创新

追求卓越

Constant innovation, Striving for excellence

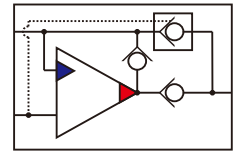

X超大流量系列 X Large Series

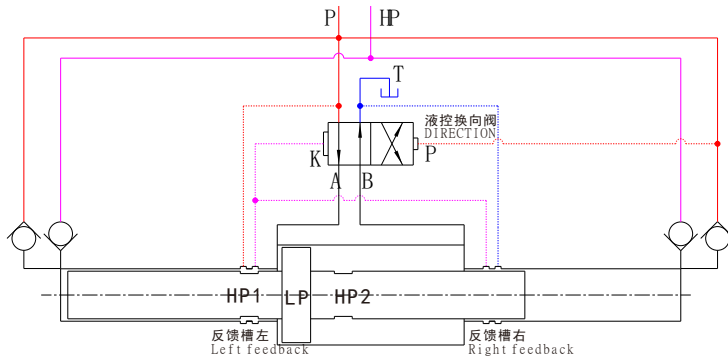

**专利产品
侵权必究**
专利号:CN115451156A

X超大流量系列为双向往复增压,其工作原理如上图所示

- 1、图示这个状态下,液控换向阀左侧小面积反馈腔与P口接通,右边大面积反馈腔经过反馈槽左与P口相通,由于液控换向阀右边反馈面积大于左边反馈面积,这时候,液控换向阀将往右边移动。
- 2、液控换向阀往右移动换向后,P口液压油经过液控换向阀,达到增压大活塞LP左腔,推动增压大活塞LP往右边移动,增压大活塞LP右腔液压油则经过液控换向阀后回到T口。增压大活塞LP往右边移动的同时,推动增压小活塞HP2压缩右边高压腔液体,提高压力,再从HP口输出。
- 3、当增压大活塞LP移动到右边后,反馈槽右将连通,液控换向阀右边大面积反馈腔经过反馈槽右与T口接通,这时候将推动液控换向阀往左边移动。
- 4、液控换向阀往左边移动到位后,增压大活塞又开始往左边运动,原理和之前一样,使左边输出高压。

如此往复左右运动,实现连续增压。

X large flow series is dual-acting booster, and its working principle is shown in the above figure

1. In the figure, the small area feedback chamber on the left of the hydraulic control directional valve is connected with port P, and the large area feedback chamber on the left is connected with port P through the left feedback tank. Since the feedback area on the right side of the hydraulic control directional valve is greater than that on the left. At this time, the hydraulic control directional valve will move to the right.
2. When the hydraulic control directional valve moves to the right, the hydraulic oil at port P passes through the hydraulic control directional valve to reach the left chamber of the large piston LP, and pushes the large piston LP to move to the right. The hydraulic oil in the right chamber of the large piston LP returns to port T after passing through the hydraulic control directional valve. While the large piston LP moves to the right, push the small piston HP2 to compress the liquid in the high-pressure chamber on the right, increase the pressure, and then output it from the HP port.
3. When the large piston LP moves to the right, the right side of the feedback tank will be connected, and the large-area feedback chamber on the right side of the hydraulic control directional valve will be connected with port T through the feedback tank, then the hydraulic control directional valve will go to the left.
4. After the hydraulic control directional valve moves to the left in place, the large piston LP starts to move to the left again. The principle is the same as before, making the left output high pressure. Such reciprocating left and right movement realizes continuous pressurization.

德思宏超大流量液压增压器X系列,具有以下特点。

The X series booster with extra large flow has the following characteristics:

- 1、内部集成液控换向阀,连续增压,液控换向阀**专利技术**,动作无死点。

Internal integrated direction valve, continuous pressurization, **Patented technology**, no stuck design.

- 2、双向增压,增压速度快。

Dual-acting, fast charging.

- 3、压力自动补偿,当低压压力P与高压压力HP达到压力平衡时候,增压器停止动作,当高压压力泄漏导致压力下降时,增压器又开始动作,继续补偿泄漏压力,实现永不掉压。Pressure auto-compensation, when the low pressure P and high pressure HP reach the pressure balance, the booster stops working, when the high pressure pressure leak causes the pressure to drop, the booster starts to operate again, continue to compensate the leakage pressure, to achieve never drop the pressure.

- 4、集成度高,体积小,重量轻。High integration, small size and light weight.

- 5、输出压力高,输出流量大。High output pressure and large output flow.

- 6、活塞与孔采用间隙密封,寿命长。The piston and the hole are sealed by gaps, the service life is long

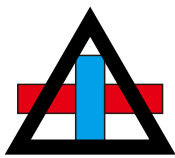

专注于液压增压器的研发

Focus on the research of hydraulic booster

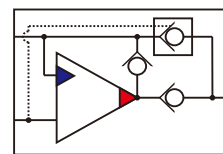

X超大流量系列 X Large Series

X60参数表

X60 PARAMETER TABLE

增压比 RATIO	额定输入流量 INPUT LPM	额定输出流量 OUTPUT LPM	额定输入压力 INPUT BAR	额定输出压力 OUTPUT BAR	额定频率 FREQUENCY
1.8	150	80	250	450	355
2.5	150	55	250	625	355
3.7	150	37	250	925	355
5.7	150	23	250	1425	355
6.8	150	18.5	250	1700	355
8	150	15	250	2000	355
11	100	7	250	2750	235

X80参数表

X80 PARAMETER TABLE

增压比 RATIO	额定输入流量 INPUT LPM	额定输出流量 OUTPUT LPM	额定输入压力 INPUT BAR	额定输出压力 OUTPUT BAR	额定频率 FREQUENCY
3.2	200	59	250	800	267
4.6	200	40	250	1150	267
6.7	200	26	250	1675	267
10	200	16	250	2500	267
14.5	150	7.6	172	2500	200
20	100	3.2	125	2500	134

选型示例 Examples:

X60-1.8 X60系列, 双向增压, 不带卸荷功能, 1.8比例。

X60-1.8 X60 extra large flow series booster, Dual-acting, without unloading function, intensification factors is 1.8.

X80-6.7 X80系列, 双向增压, 不带卸荷功能, 6.7比例。

X80-6.7 X80 extra large flow series booster, Dual-acting, without unloading function, intensification factors is 6.7.

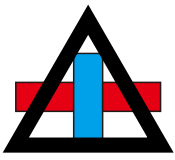

不断创新

追求卓越

Constant innovation, Striving for excellence

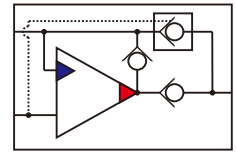

X60 安装尺寸 X60 Dimensions

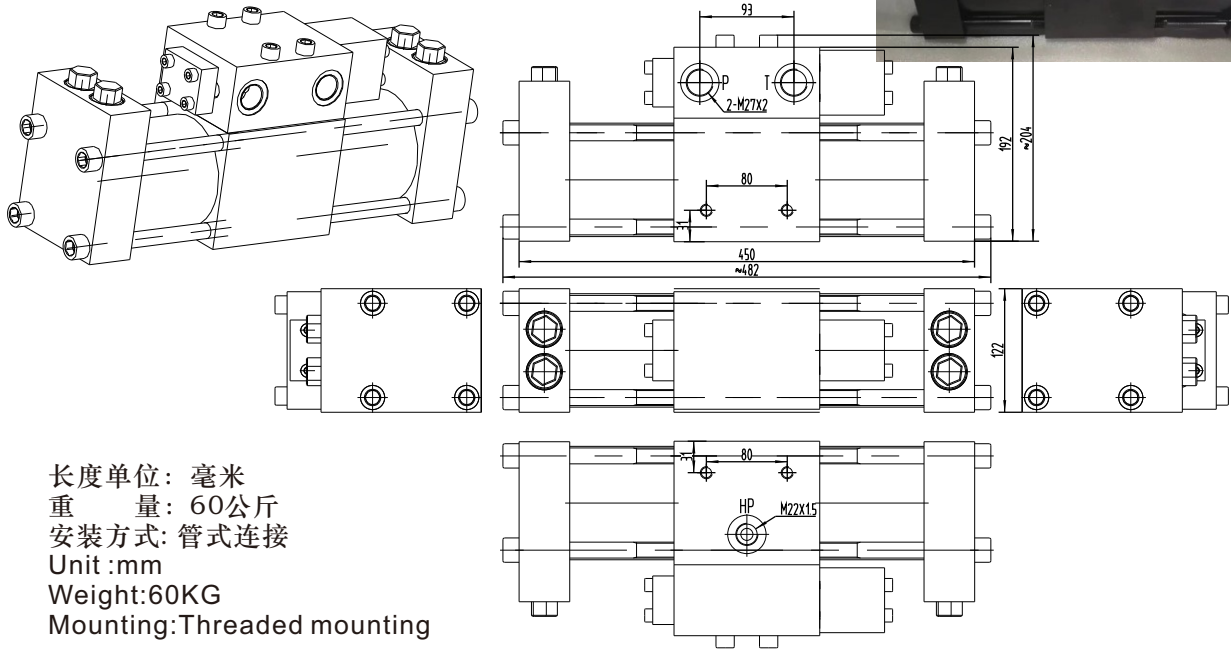
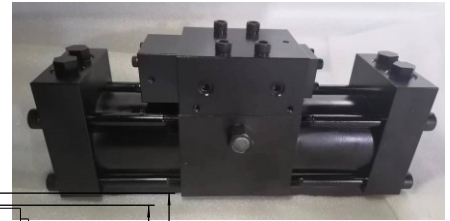

长度单位: 毫米
重量: 60公斤
安装方式: 管式连接
Unit :mm
Weight:60KG
Mounting:Threaded mounting

X80 安装尺寸 X80 Dimensions

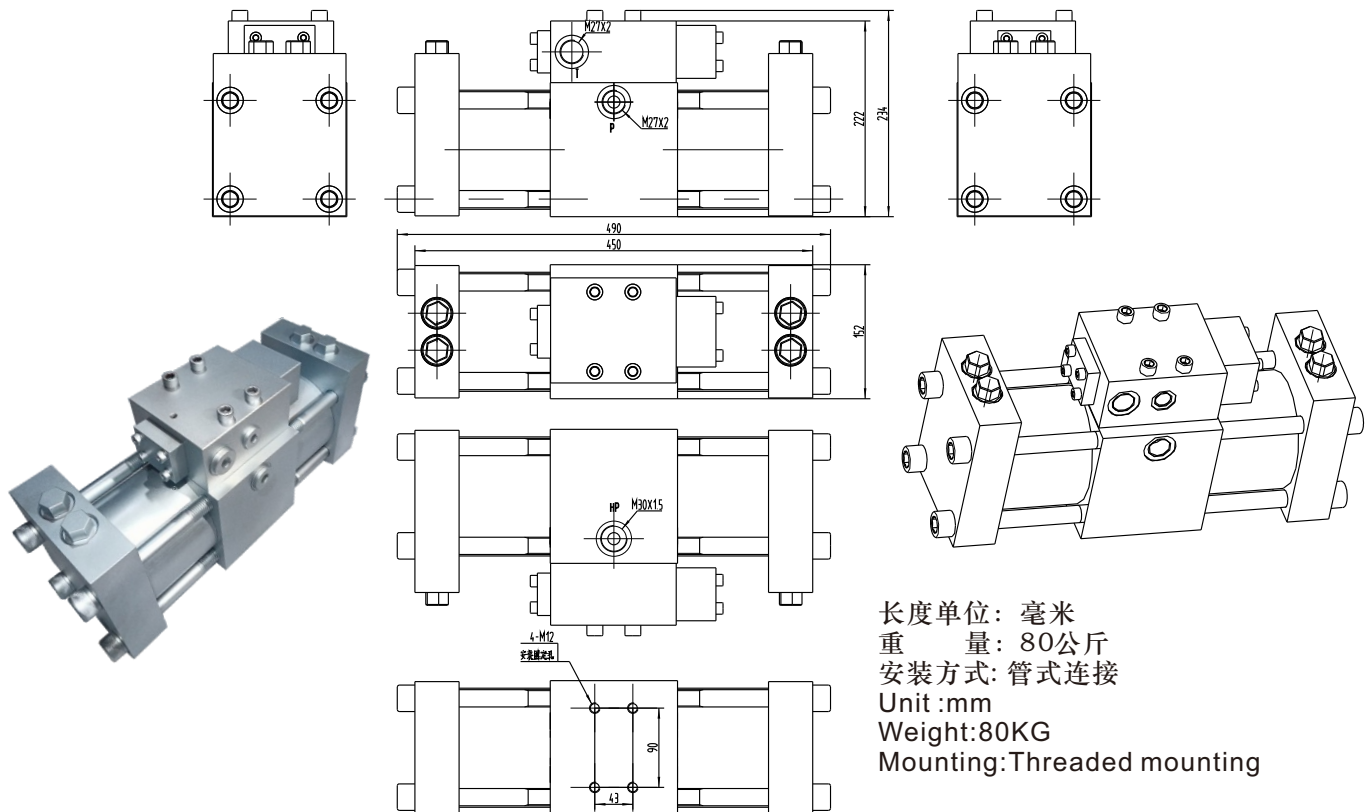

长度单位: 毫米
重量: 80公斤
安装方式: 管式连接
Unit :mm
Weight:80KG
Mounting:Threaded mounting

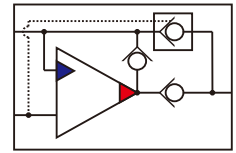
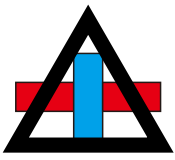

多缸双向增压器组 BOOSTER GROUP

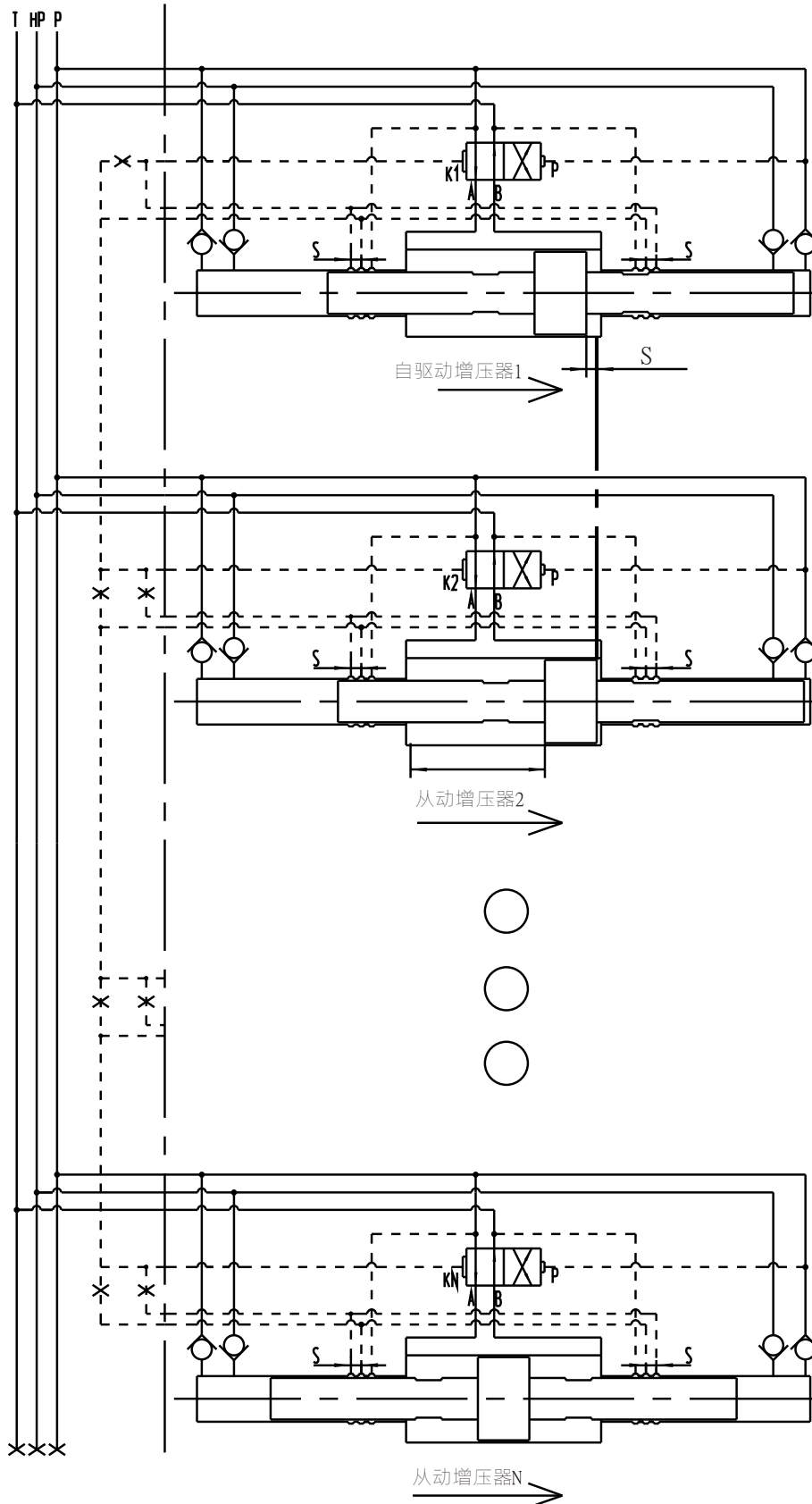

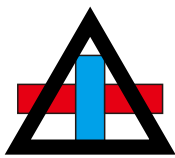

不断创新

追求卓越

Constant innovation, Striving for excellence

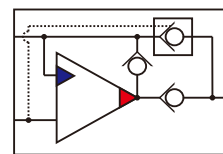

多缸双向增压器组 BOOSTER GROUP

活塞运动行程位置图

PISTON POSITION

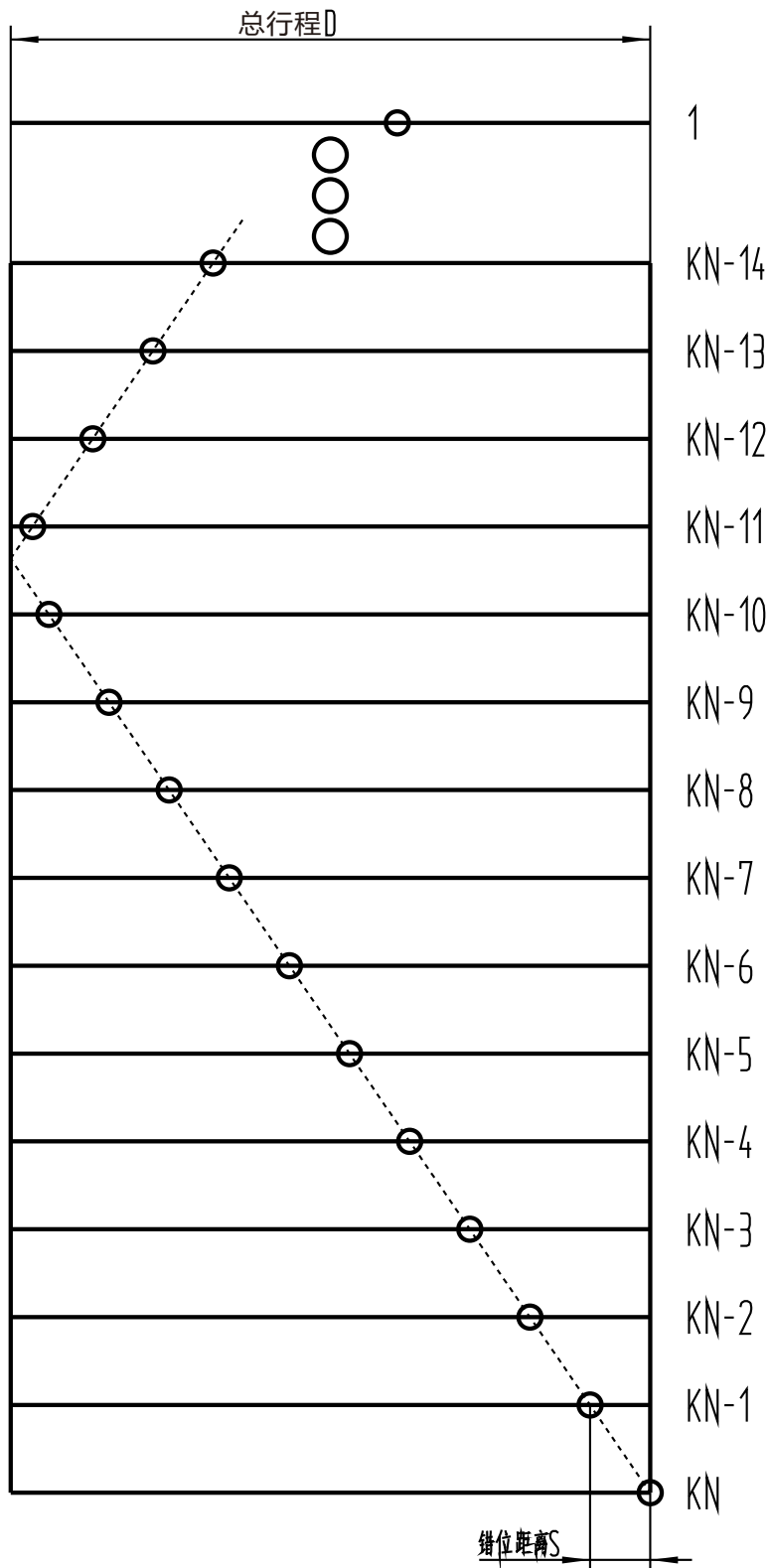

产品特点 低波动, 大流量

单个往复增压器在往复运动过程中, 当液控换向阀换向时候, 高压输出为0, 这时候高压端会产生压力波动。采用德思宏多缸增压器组, 通过各个增压器活塞运动位置错位, 实现各个增压器错位增压, 从而实现任何时候高压输出都不为0, 减少高压端波动。采用多个增压器时候, 通过错位距离的调整, 让其换向首尾相接, 可以实现和柱塞泵一样连续输出流量。具体参数根据选择的单个增压器参数乘以个数计算。

选型方法:

如, 双联X60增压器6.8倍, 则型号为DX60-6.8。
三联则3X60-6.8。

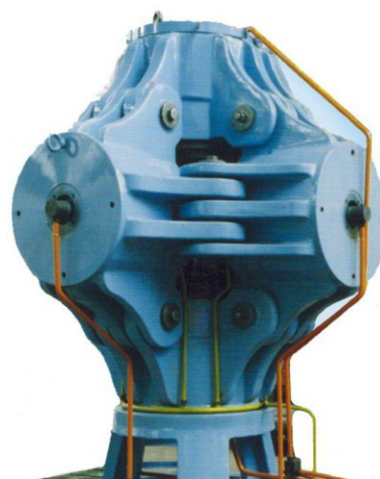

六面顶压机应用

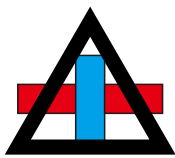

专注于液压增压器的研发

Focus on the research of hydraulic booster

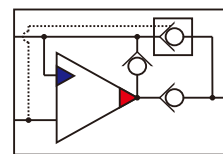

双向增压器定制 CUSTOMIZATION

54长条形液压增压器

54 LONG BOOSTER

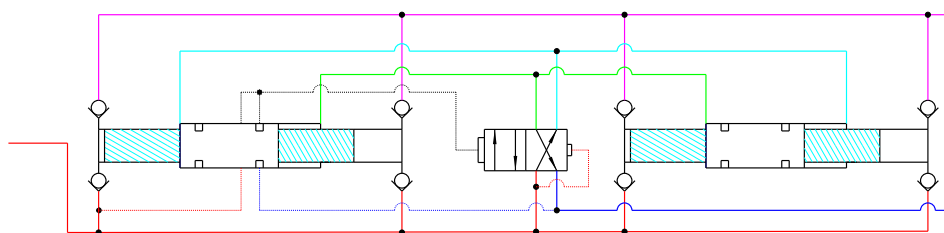

水压增压器

WATER BOOSTER

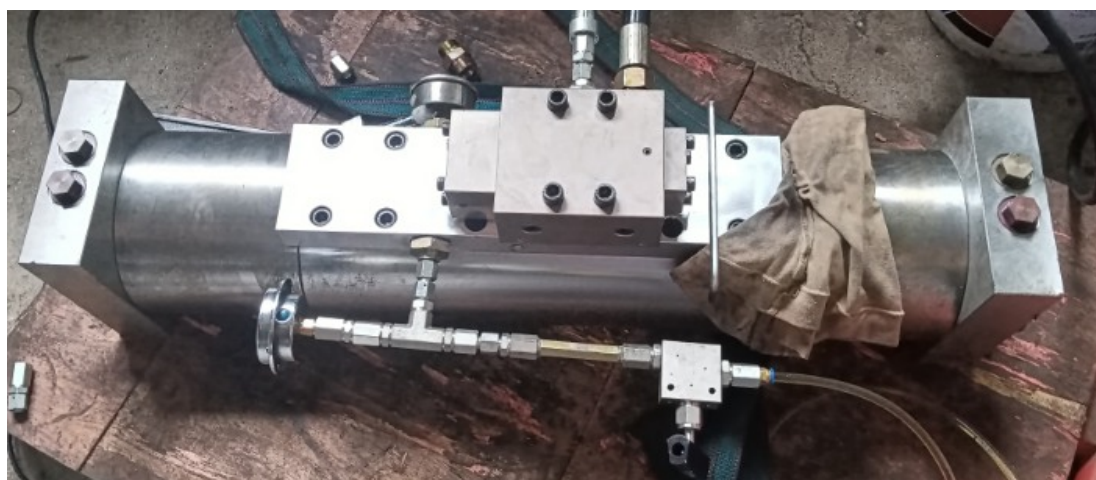

油水增压器

DUALMEDIA BOOSTER

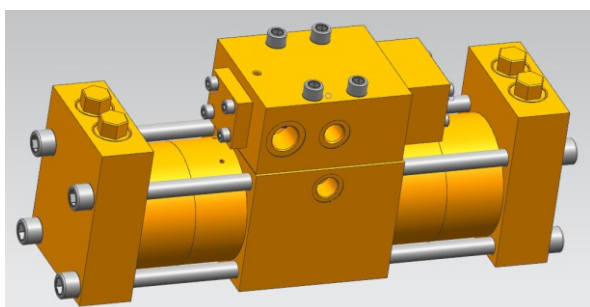

救援增压器

RESCUE BOOSTER



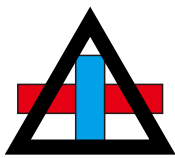

不断创新

追求卓越

Constant innovation, Striving for excellence

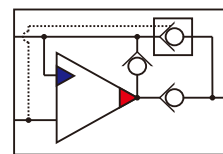

大流量超高压系统

Large flow high pressure

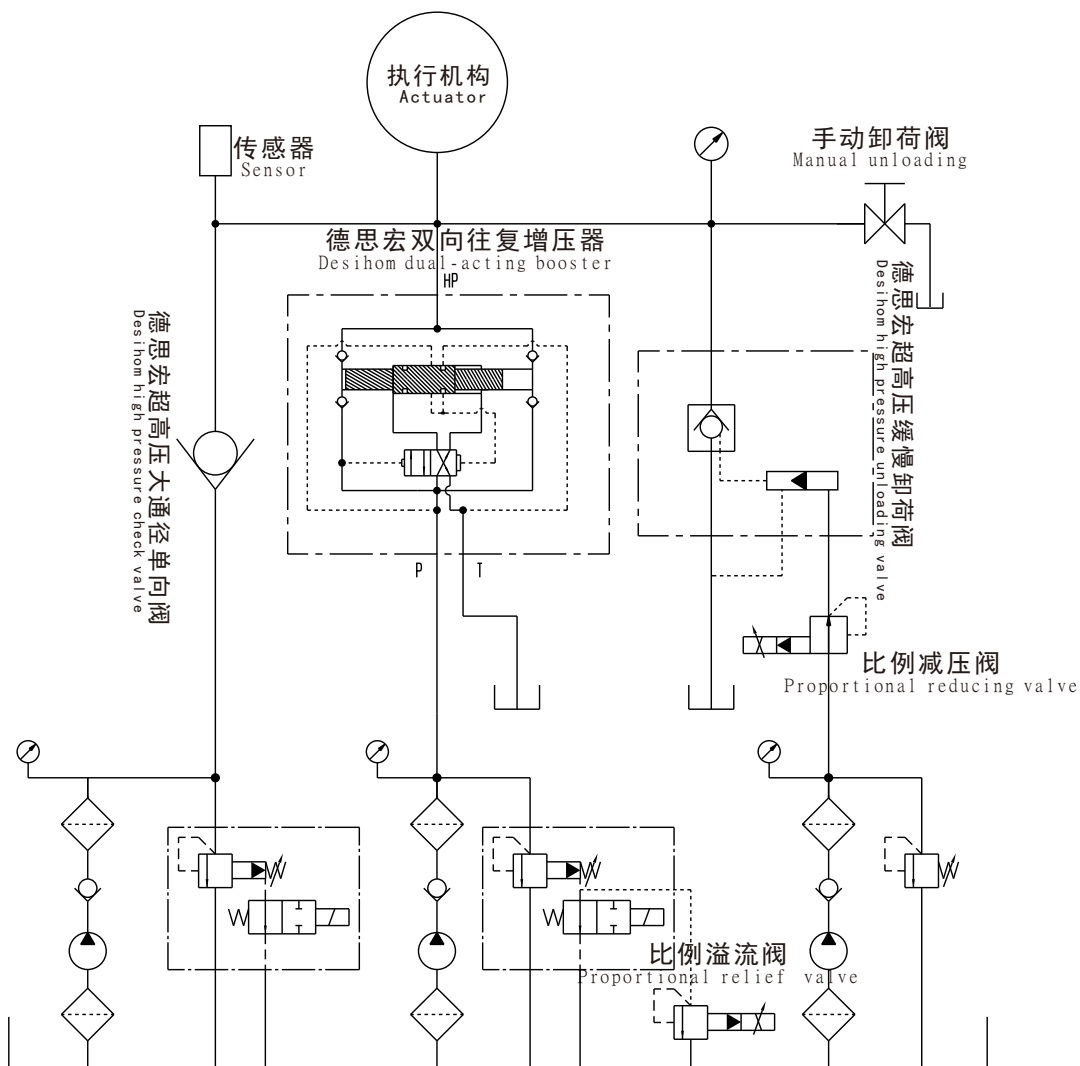

应用行业

工程机械

万吨压机

压铸机

金刚石压机

寿命测试台

压力成型机

ENGINEERING

LARGE PRESS

DIE-CASTING

DIAMOND PRESS

TESTING

EXPANSION



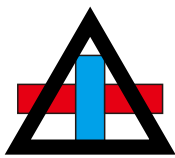

专注于液压增压器的研发

Focus on the research of hydraulic booster

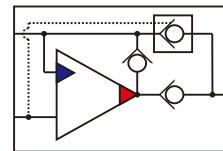

增压器的合理使用

为保证液压增压器的性能,使用工况必须满足以下要求:

In order to ensure the performance of the hydraulic booster, the working conditions must meet the following requirements:

- 1、过滤精度: 10um Filtering accuracy: 10um
- 2、介质温度: 60度以下 Medium temperature: below 60 degrees.
- 3、流量和压力: 低于额定值 Flow and pressure: below rated value.

一个液压增压器的好坏不仅取决于产品本身的质量, 还因整个液压系统的合理性, 污染程度等有关。其中污染程度是决定液压增压器寿命的主要因素。The quality of a hydraulic booster depends not only on the quality of the product itself, but also on the rationality of the whole hydraulic system, pollution level and so on. The pollution degree is the main factor determining the life of hydraulic booster.

右图为两种不同工况下适用的液压系统。The principle diagram is applicable to the hydraulic system under two different working conditions.

一、压力型系统主要用于压力要求高而流量小的系统, 它具有结构简单, 性能稳定等优点; Pressure-type system is mainly used in the system with high pressure requirement and low flow rate. It has the advantages of simple structure and stable performance.

二、流量型系统是最常用的系统, 它在低压时候能提供较大的流量, 同时它还有如下好处: Flow-type system is the most commonly used system, it can provide a large flow at low pressure, at the same time it has the following advantages:

- 1、低于顺序阀调定的低压状态下, 油液大部分直接通过液控单向阀进入负载油缸, 少部分经过液压增压器, 这时增压器不动作, 可以减少液压增压器的动作时间, 延长使用寿命。Under the low pressure condition which is lower than the sequence valve, most of the oil enters the load cylinder directly through the pilot operated check valve, a small part passes through the hydraulic booster, at this time the hydraulic booster does not move, which can reduce the action time of the hydraulic booster and prolong the service life.
- 2、液压油直接通过液控单向阀进入负载油缸, 这样比单独通过液压增压器的走的流量大, 减少低压充液时间。The hydraulic oil enters the load cylinder directly through the pilot operated check valve, so the flow rate is larger than that through the hydraulic booster alone, and the filling time of low pressure is reduced.
- 3、油缸卸荷时候通过液控单向阀卸荷, 不经过液压增压器, 始终保证液压增压器的清洁。When the cylinder unloads through the pilot operated check valve, it does not pass through the hydraulic booster, ensure the cleanliness of the hydraulic booster.

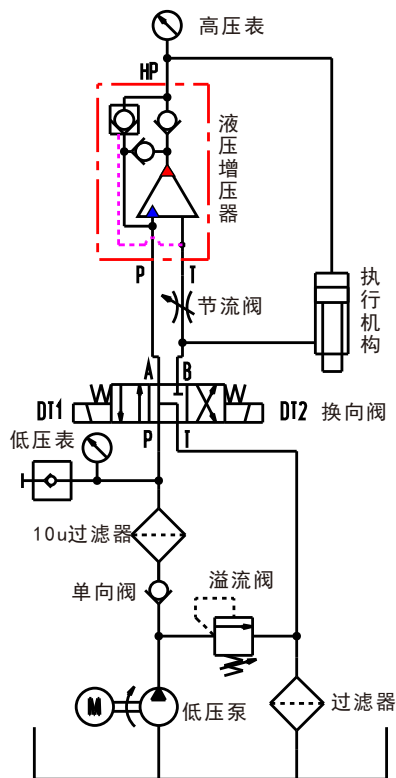

压力型系统
Pressure-type System

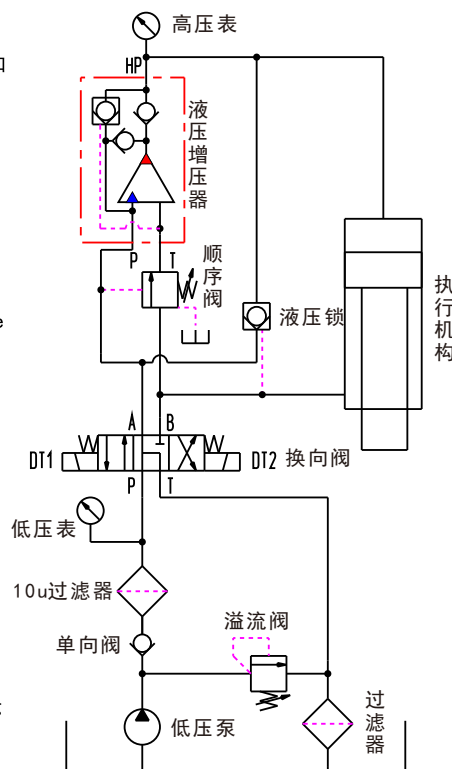

流量型系统
Flow-type System

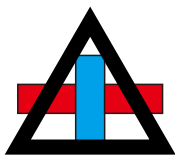

不断创新

追求卓越

Constant innovation, Striving for excellence

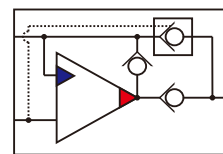

增压器集成阀块

T系列增压集成

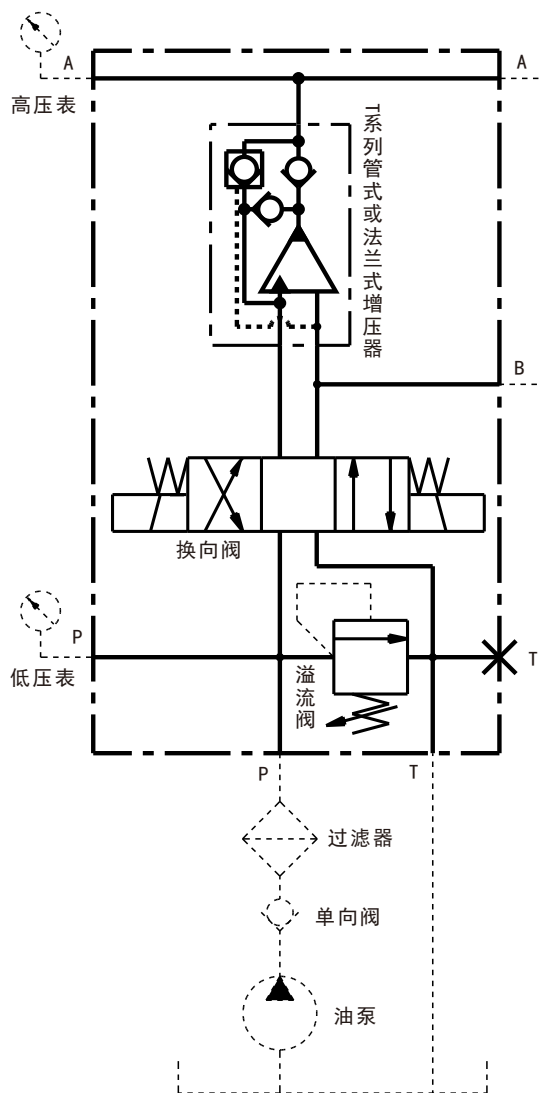

- 阀块型号：TDJ-01 (不包含阀和增压器)
- 外形尺寸：长78X宽56X高63mm。
- 重量：约2KG。

□ 可装部件：T系列管式增压器或法兰式增压器，插装溢流阀，低压压力表，高压压力表，电磁换向阀。

• 油口尺寸：P、T、A、B口均为G1/4螺纹。

适用工况：

- 1、系统某支路需要高压；
- 2、低压泵站转为高压泵站。

性能参数：

根据T系列增压器参数表可知，本阀块装配各阀和增压器后，可以
 输入压力：0-20MPa
 输入流量：0-15L/min
 输出压力：0-200MPa
 输出流量：3.45-0.8L/min

使用举例

☒某设备负载油缸的无杆腔需要压力60MPa，流量约1.2L/min的高压液压油驱动，回程不需要高压。

根据BST-T系列增压器参数表可知，增压比3.4倍率的额定输出压力为680bar，临界输出流量为2.7L/min，可以满足设备的压力和流量要求。则增压器可以选择BST-TY-3.4G，或者BST-TY-3.4F。

根据参数表可知增压器输入15L/min流量时候输出2.7L/min流量，则输出1.2L/min流量时候需要6.7L/min输入流量，考虑高压下的泄漏损失，输入流量需要约为6.7/0.8=8.4L/min。

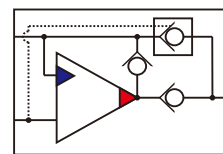
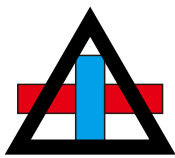

T系列顺序增压

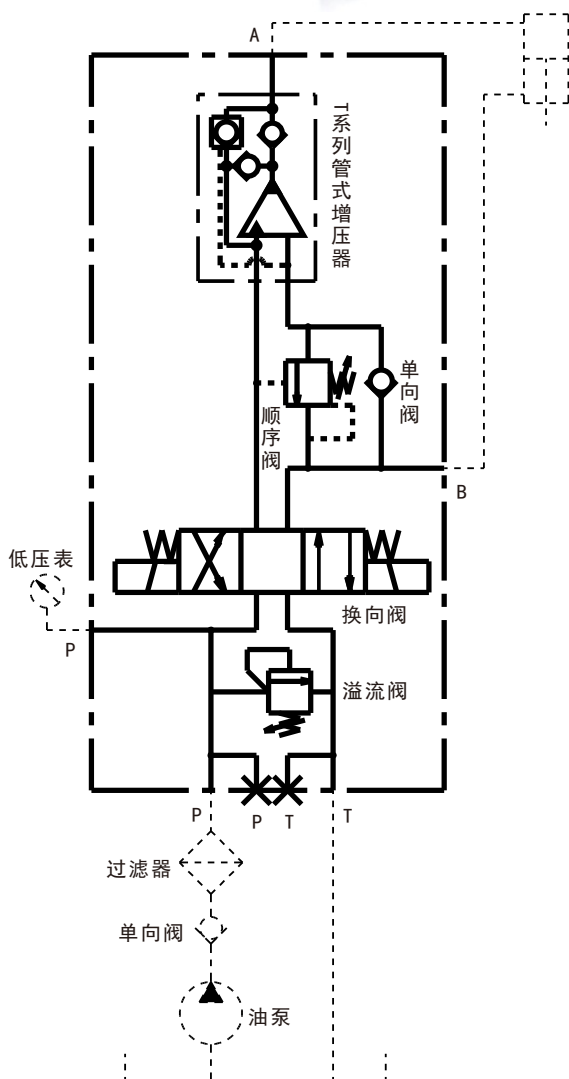
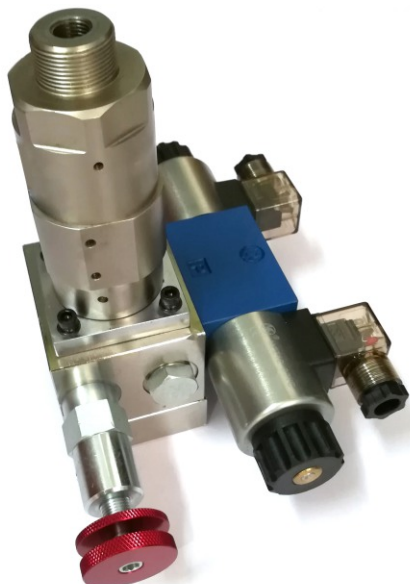

- 阀块型号：TDJ-02 (不包含阀和增压器)
- 外形尺寸：长80X宽72X高78mm。
- 重量：约3KG。
- 可装部件：T系列管式增压器，插装顺序阀，插装单向阀，低压压力表，叠加溢流阀，电磁换向阀。
- 油口尺寸：P、T、A、B口均为G1/4螺纹。

适用工况：

- 1、系统某支路需要高压；
- 2、低压泵站转为高压泵站；
- 3、低压系统大流量工作，高压系统小流量工作。

性能参数：

根据T系列增压器参数表可知，本阀块装配各阀和增压器后，可以

输入压力：0-20MPa

输入流量：0-15L/min

低压输出压力：通过顺序阀调节，压力自动切换

低压输出流量：0-15L/min

输出压力：0-200MPa

输出流量：3.45-0.8L/min

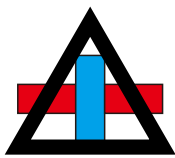

不断创新

追求卓越

Constant innovation, Striving for excellence

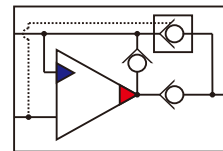

T系列双向增压

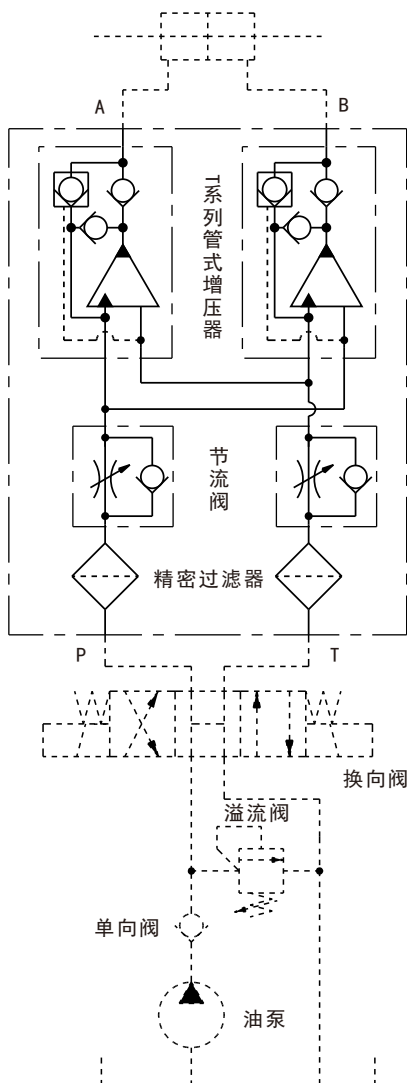
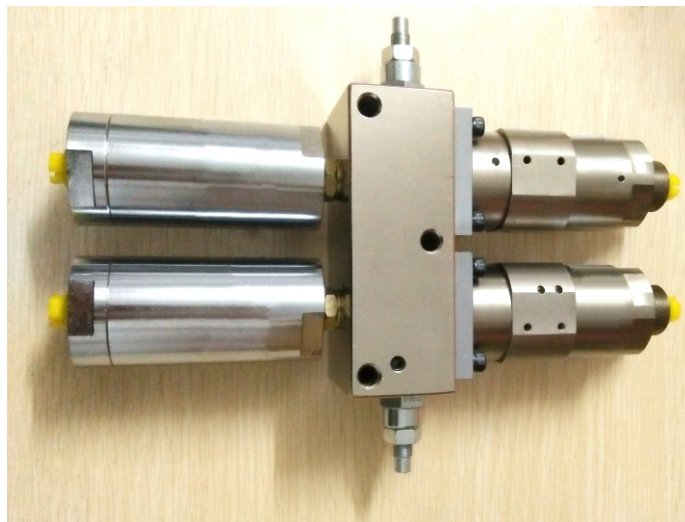

- 阀块型号：TDJ-03 (不包含阀和增压器)
- 外形尺寸：长140X宽70X高50mm。
- 重量：约3.7KG。
- 可装部件：T系列管式增压器2个，插装节流阀2个，精密过滤器2个。
- 油口尺寸：P、T、A、B口均为G1/4螺纹。

适用工况：

- 1、系统某支路双向都需要高压；
- 2、低压泵站转为高压泵站；

性能参数：

根据T系列增压器参数表可知,本阀块装配各

阀和增压器后,可以

输入压力：0-20MPa

输入流量：0-15L/min

输出压力：0-200MPa

输出流量：3.45-0.8L/min

注：可以根据客户需要设计其他功能阀块。

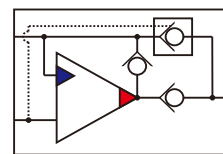
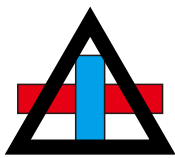

M系列增压集成

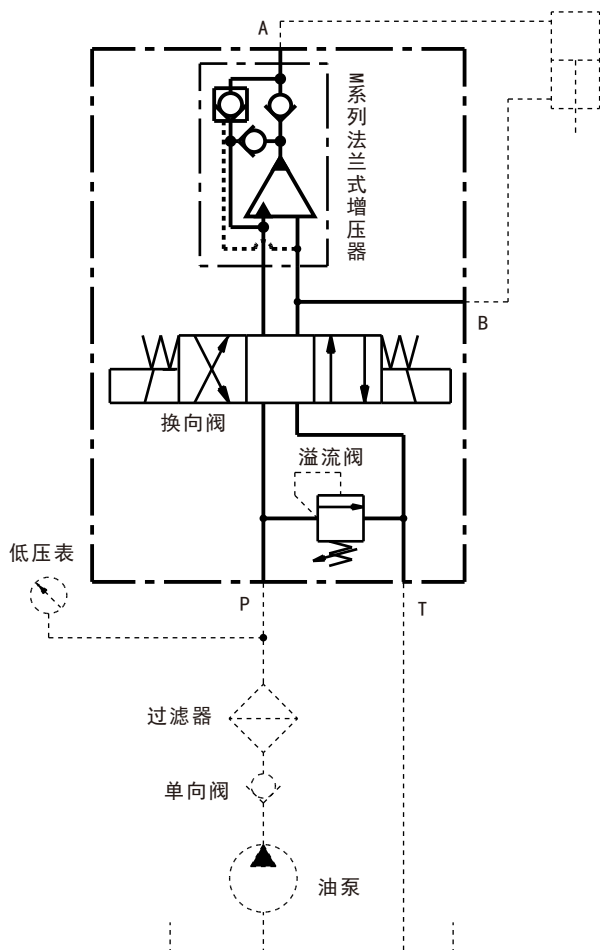
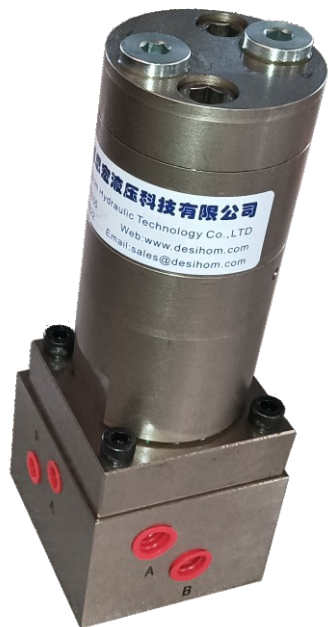

- 阀块型号：MDJ-01 (不包含阀和增压器)
- 外形尺寸：长84X宽90X高60mm。
- 重量：约3.5KG。
- 可装部件：M系列管式增压器，叠加溢流阀，电磁换向阀。
- 油口尺寸：P、T、A、B口为G3/8螺纹。

适用工况：

- 1、系统某支路需要高压；
- 2、低压泵站转为高压泵站；

性能参数：

根据M系列增压器参数表可知,本阀块装配各阀和增压器后,可以

输入压力：0-20MPa

输入流量：0-35L/min

输出压力：0-80MPa

输出流量：8.3-4.5L/min

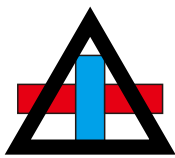

不断创新

追求卓越

Constant innovation, Striving for excellence

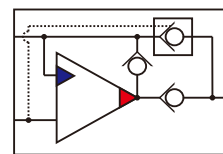

M系列顺序增压



装进盒子，总重13KG

- 阀块型号：MDJ-02 (不包含阀和增压器)
- 外形尺寸：长80X宽84X高84mm。
- 重量：约4.2KG。
- 可装部件：M系列管式增压器，单向顺序阀。
- 油口尺寸：A1、A2、B口为G3/8螺纹，X口为G1/4螺纹。

适用工况：

- 1、系统某支路需要高压；
- 2、低压泵站转为高压泵站；
- 3、低压系统大流量工作，高压系统小流量工作。

性能参数：

根据M系列增压器参数表可知,本阀块装配各阀和增压器后,可以

输入压力：0-20MPa
 输入流量：0-35L/min
 低压输出压力：通过顺序阀调节，压力自动切换
 低压输出流量：0-35L/min
 输出压力：0-80MPa
 输出流量：8.3-4.5L/min

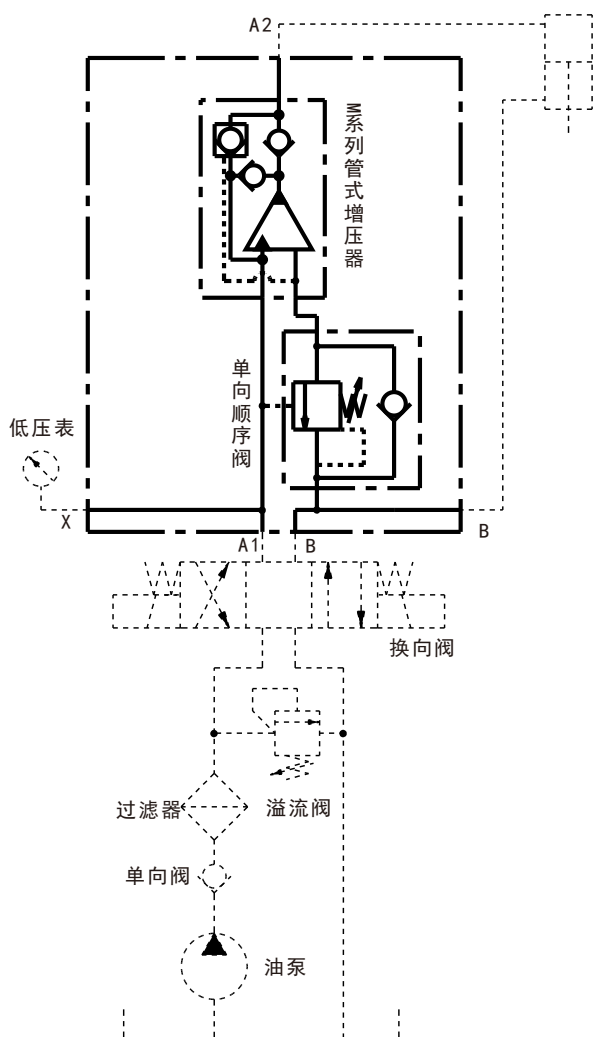

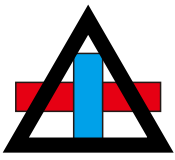

专注于液压增压器的研发

Focus on the research of hydraulic booster

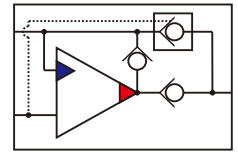

M系列双向增压

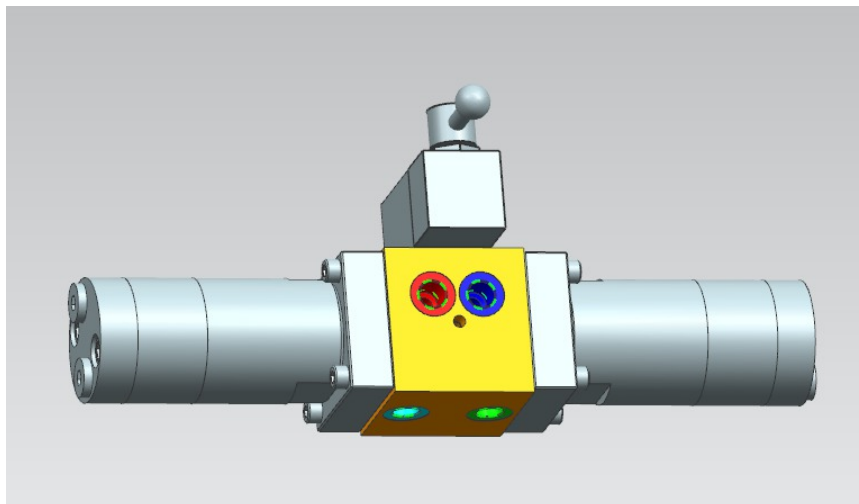
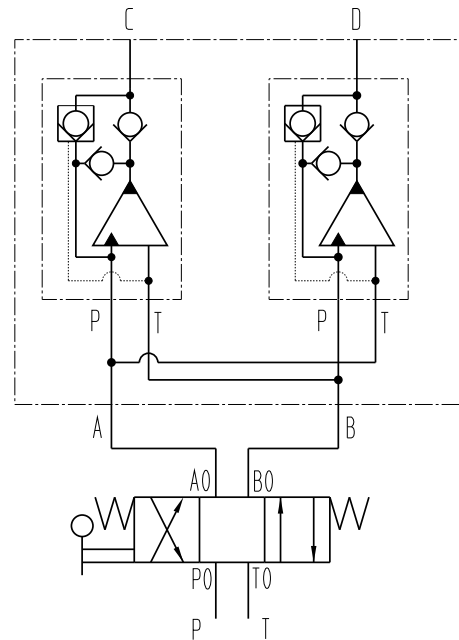
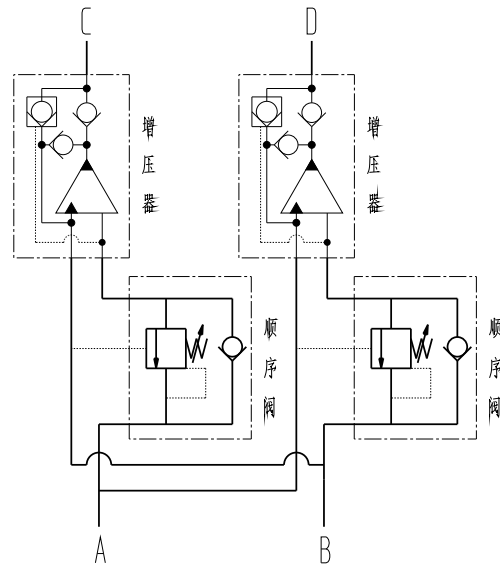

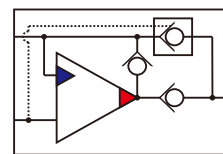
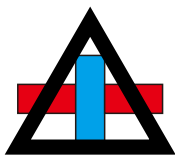

其他增压集成



L系列单个集成换向阀



L系列三个集成

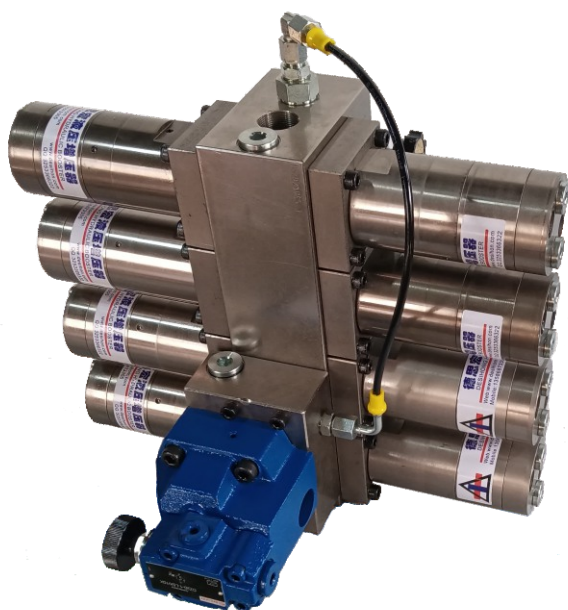

M系列8个集成顺序阀



Mg系列增压卸荷一体

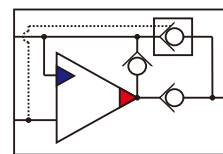
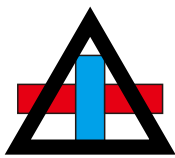

超高压动力单元

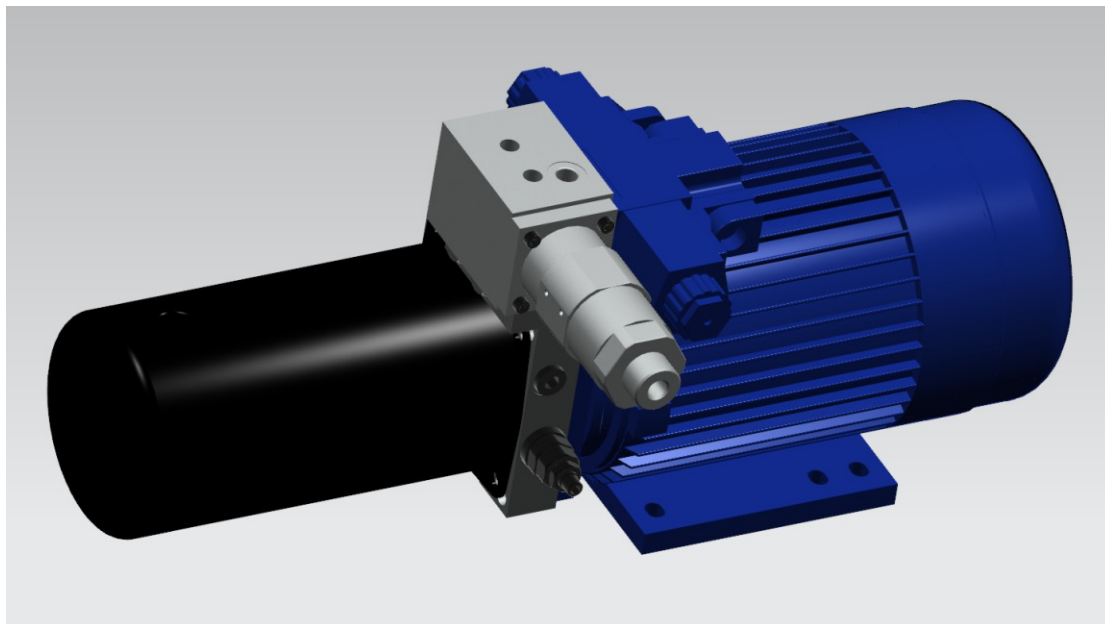

超高压动力单元

• 型 号：DL-T*. *-*.*-***-**

□ 包含组件：圆形油箱，过滤器，齿轮泵，溢流阀，电磁换向阀、管式增压器。

• 型号示例说明：DL-T3.4-0.8-075-02

• 1、T3.4：T系列增压器，增压比3.4。

• 2、0.8：齿轮泵排量0.8CC/rev，压力21MPa。

• 3、075：电机功率0.75KW，转速1450r/min。

• 4、02：油箱容积2L。

• 5、输出流量和压力：根据T系列增压器参数表可知，输出流量约0.2L/min，最大输出压力68MPa。

• 6、外形尺寸：长530X宽285X高200mm

• 7、油口尺寸：A、B口均为G1/4螺纹。

注：动力单元电机可选最大功率为2.2KW，请根据电机功率，输出压力选择合适排量的齿轮泵。

德思宏可以根据客户需求定制各种不同流量和压力以及不同功能的超高压动力单元。

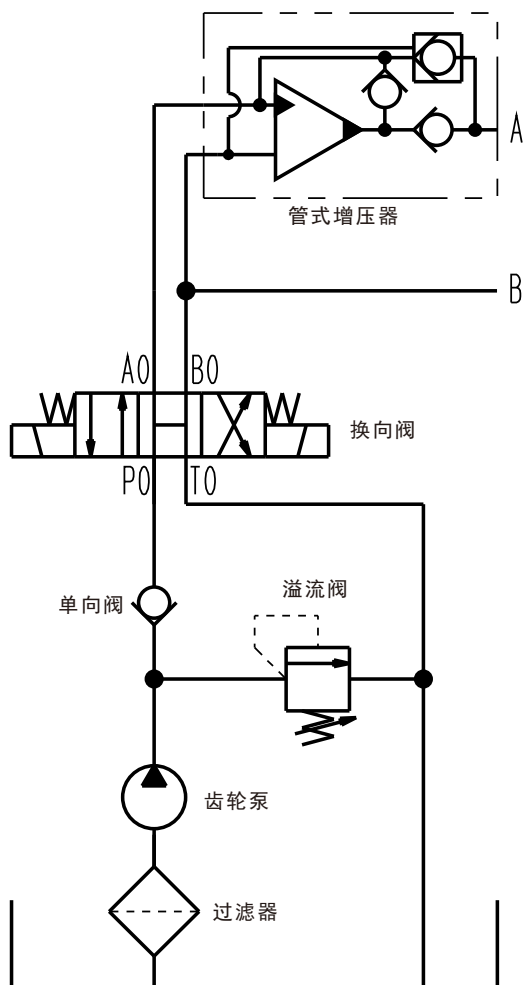

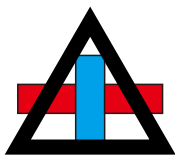

不断创新

追求卓越

Constant innovation, Striving for excellence

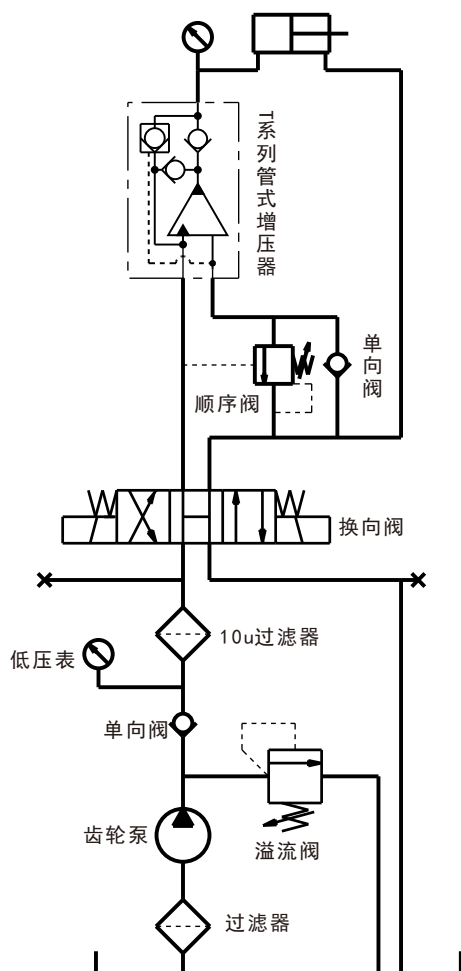
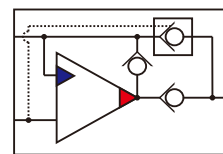

两级压力超高压动力单元

- 型号: DLD-T*. *-*.*-***-**
- 包含组件: T系列管式增压器, 圆形油箱, 过滤器, 齿轮泵, 溢流阀, 单向阀, 低压表, 10u过滤器, 电磁换向阀、顺序阀, 高压压力表。
- 型号示例说明: DLD-T3.4-0.8-075-02
- 1、T3.4: T系列增压器, 增压比3.4。
- 2、0.8: 齿轮泵排量0.8CC/rev, 压力21MPa。
- 3、075: 电机功率0.75KW, 转速1450r/min。
- 4、02: 油箱容积2L。
- 5、输出流量和压力:
 - 一级压力0-20MPa (顺序阀调节), 流量1.16L/min
 - 二级压力0-68MPa, 流量0.2L/min
- 6、外形尺寸: 长530X宽285X高200mm
- 7、油口尺寸: A、B口均为G1/4螺纹。

注: 动力单元电机可选最大功率为2.2KW, 请根据电机功率, 输出压力选择合适排量的齿轮泵。

德思宏可以根据客户需求定制各种不同流量和压力以及不同功能的超高压动力单元。

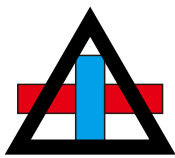

专注于液压增压器的研发

Focus on the research of hydraulic booster

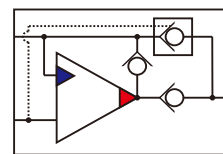

超高压控制系统



此款不含
低压液压系统



手动控制增压系统

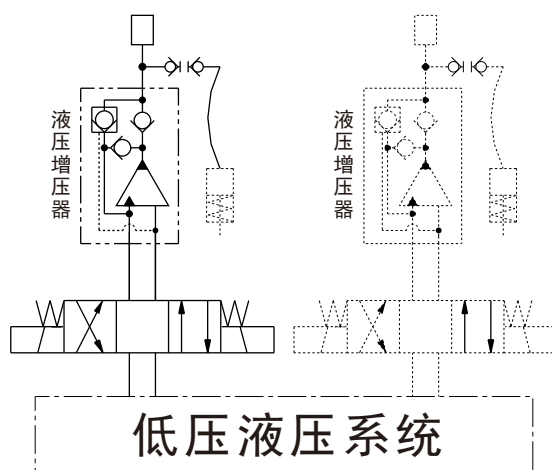

超高压控制系统

组成：由低压液压系统加液压增压器，结合电器系统组成。

功能

- 1、具有压力输出，压力卸荷功能。
- 2、输出压力0-140MPa，输出时间点可通过触摸屏设置。
- 3、压力可通过手动调节，也可以通过触摸屏调节。
- 4、输出可选择1路、2路、4路输出。
- 5、水冷却。
- 6、液位监视，温度监视功能。
- 7、具有开机时间记录功能，累计增压次数记录功能。
- 8、各种保护功能。

系统应用

液压元件的耐压测试、寿命测试

为裁剪、冲孔、折弯等设备提供动力

使用要求

380V三相电

根据使用情况, 给设备接水冷

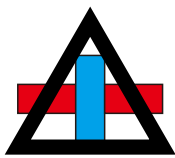

不断创新

追求卓越

Constant innovation, Striving for excellence

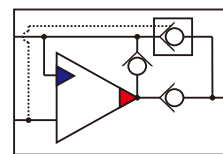

液压附件

BV超高压卸荷阀

德思宏BV超高压卸荷阀是一款专为X系列液压增压器开发的充液卸荷产品。卸压比达到10:1, 通径16MM, 高压额定压力达到200MPa。

BV ultra-high pressure unloading valve of Desihom is a unloading of liquid products which special developed for X series hydraulic booster , The pressure relief ratio is 10:1, the diameter is 16MM, and the rated pressure of high pressure reaches 200MPa.



参数表

型号 TYPE	额定输入流量 INPUT LPM	卸压比 PILOT RATIO	额定压力 RATED BAR	重量 WEIGHT KG
BV-16-200	200	10	2000	26

安装尺寸

Dimensions

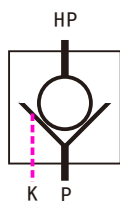

长度单位: 毫米
重量: 26KG
安装方式: 管式安装
Unit: mm
Weight: 26kg
Mounting: Threaded mounting

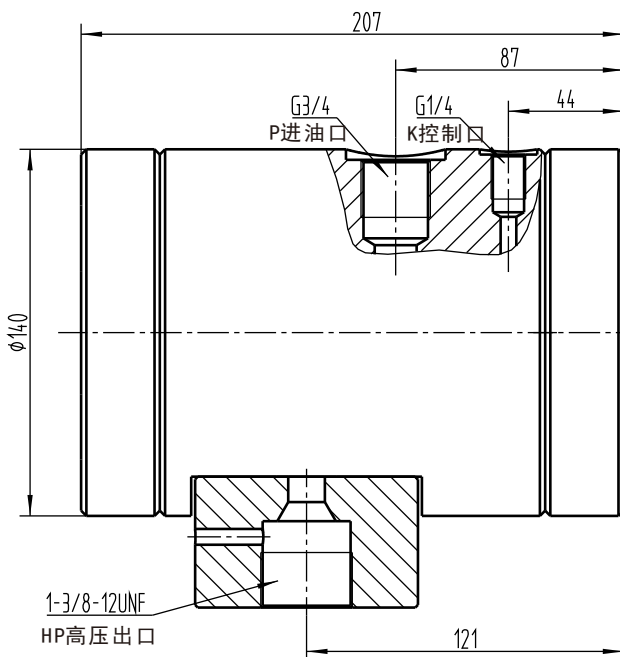

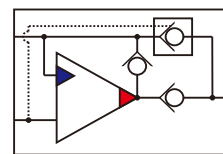
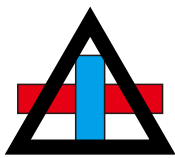

液压附件

BM超高压缓慢卸荷阀

德思宏BM超高压缓慢卸荷阀可以缓慢卸载高压侧压力。卸压比达到16:1, 通径11MM, 高压额定压力达到200MPa。

BM ultra-high pressure slowly unloading valve of Desihom can relief high pressure slowly, The pressure relief ratio is 16:1, the diameter is 11MM, and the rated pressure of high pressure reaches 200MPa.

工作原理: K口压力顶住缓慢卸荷阀密封顶针, 使HP口压力油不泄漏, 泄压时候, 缓慢减少K口压力, 使顶针慢慢打开, 实现缓慢卸荷。

Principle: the pressure at port K presses against the sealed pin, so that the pressure oil at HP port does not leak. During slowly reduce the pressure at port K, so that the sealed pin can be opened slowly to realize slow unloading

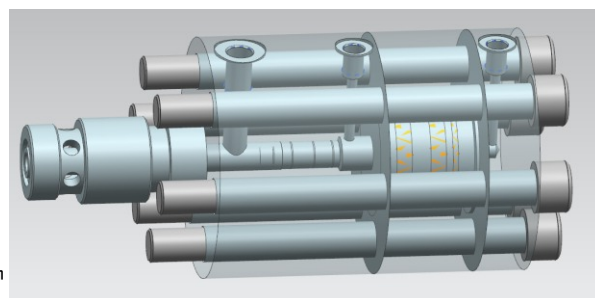

参数表

型号 TYPE	额定输入流量 INPUT LPM	卸压比 PILOT RATIO	额定压力 RATED BAR	重量 WEIGHT KG
BM-11	200	16	2000	24

安装尺寸

Dimensions

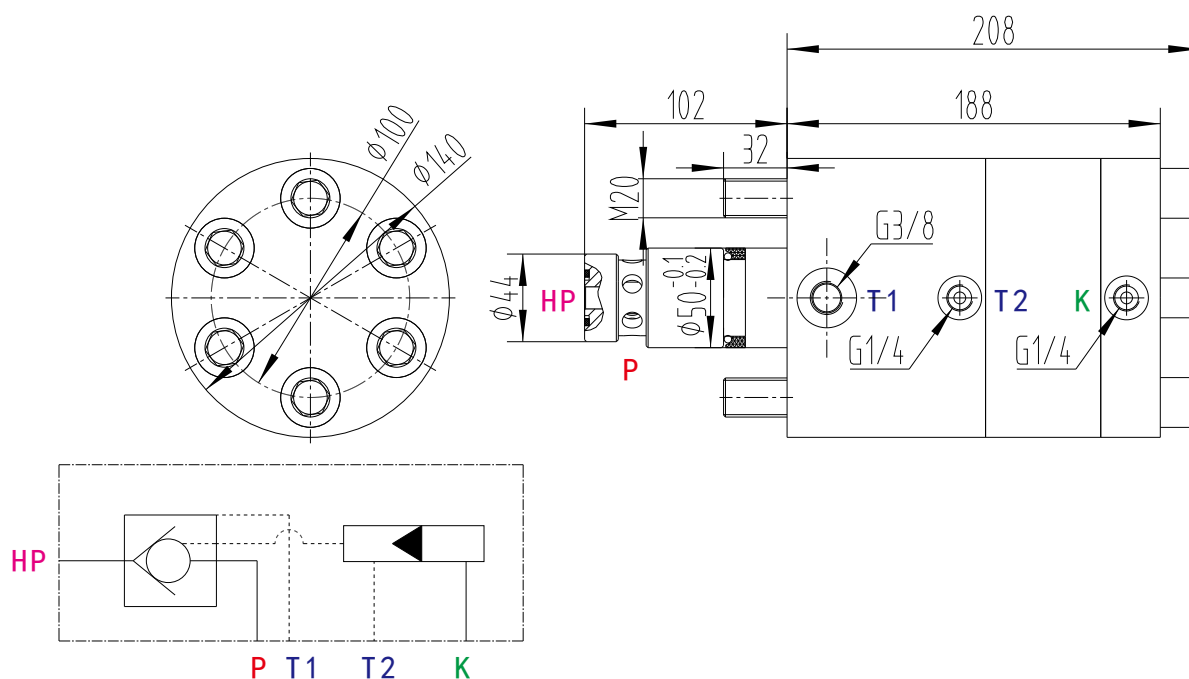

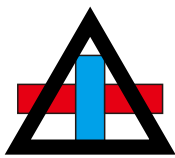

不断创新

追求卓越

Constant innovation, Striving for excellence

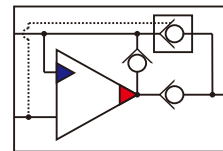

液压附件

DV超高压大单向阀

德思宏DV-30超高压单向阀, 口径30MM, 高压额定压力达到200MPa。

DV ultra-high pressure check valve of Desihom DN 30mm, the pressure reaches 200MPa.

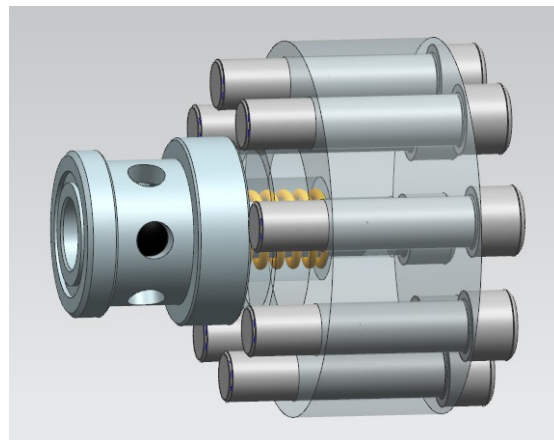

安装尺寸 Dimensions

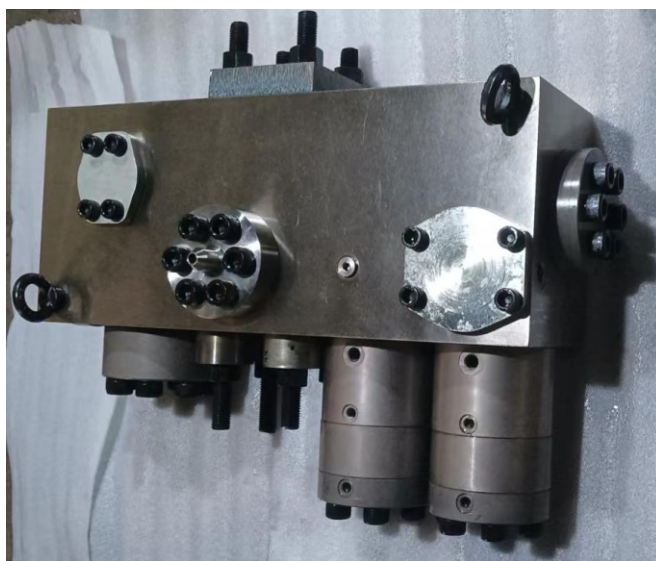
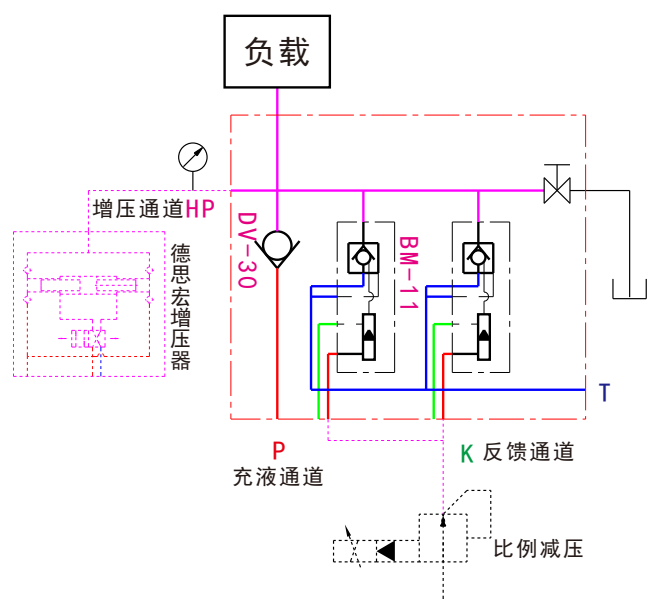
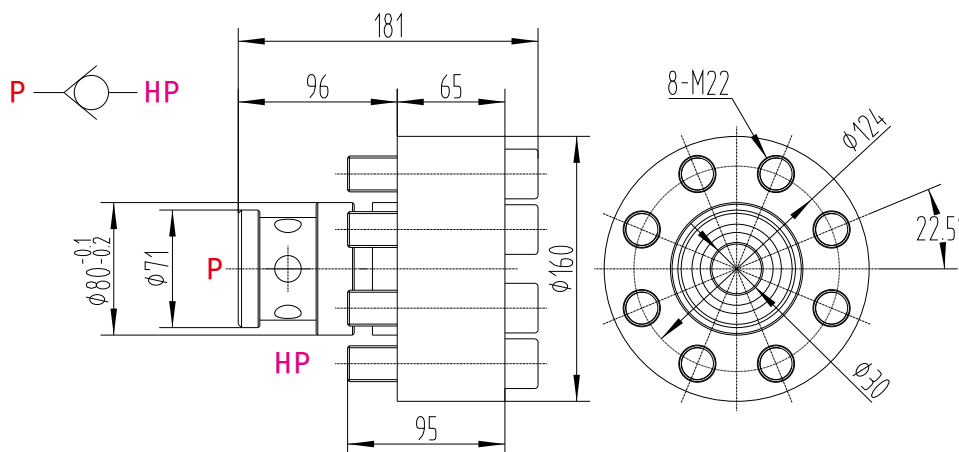

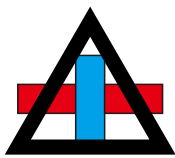

专注于液压增压器的研发

Focus on the research of hydraulic booster

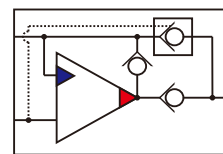

超高压过滤



德思宏BLX过滤器是一款专为液压增压器开发的高精度过滤产品。其内部采用特制的高承压烧结青铜滤芯，过滤精度高，耐压能力大。防冲击设计，使滤芯承受的液压冲击力小，使用寿命长。整体采用螺纹连接，更换滤芯方便。

The BLX filter of Desihom is a highly precise filtration product specially developed for hydraulic booster. Specially designed sintered bronze filter core with high filtration precision and high pressure resistance is adopted inside. Anti impact design makes the hydraulic impact force of the filter core small, and the service life is long. The whole thread connection is adopted to replace the filter element conveniently.

参数表

型号 TYPE	额定输入流量 INPUT LPM	过滤精度 μm	额定压力 RATED BAR	最大允许压差 DIFFERENTIAL BAR	重量 WEIGHT KG
BLX-G140	20	10	700	25	1.1

安装尺寸

Dimensions

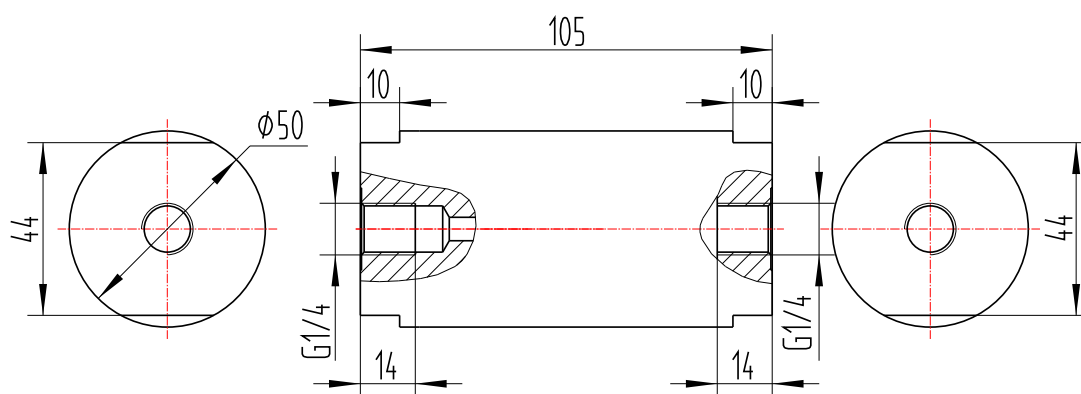

长度单位：毫米
重 量：1.1公斤
安装方式：管式连接
Unit: mm
Weight: 1.1kg
Mounting: Threaded mounting

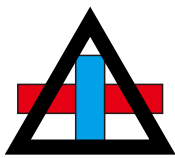

不断创新

追求卓越

Constant innovation, Striving for excellence

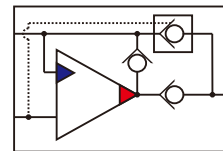

连接件

德思宏的安装板AZB系列与管式增压器相连，使增压器的进油口P和T由螺纹连接转变成法兰式连接，更方便安装。

Desihom's installation plate AZB series is connected to the threaded mounting booster, so that the inlet and outlet of the booster P and T from the threaded connection into a flange connection, more convenient for installation.

注:高压出油口HP不变。

Note: High pressure oil outlet HP remains unchanged

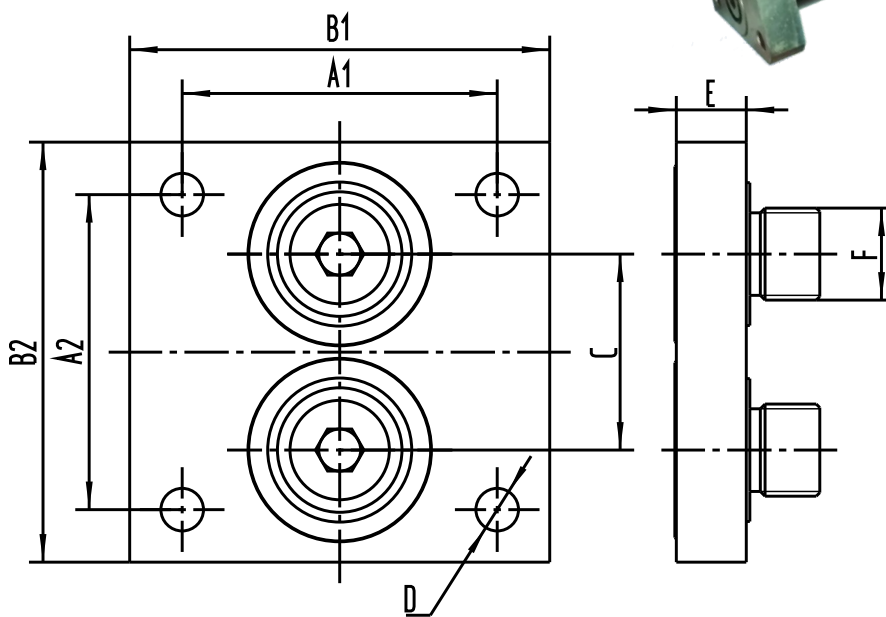

型号 TYPE	A1 mm	A2 mm	B1 mm	B2 mm	C mm	D mm	E mm	F mm
AZB-T	45	45	60	60	28	$\phi 6.1$	10	G1/4
AZBA-T	39	49	50	60	28	$\phi 6.1$	10	G1/4
AZB-M	62	62	80	80	43.6	$\phi 8.2$	15	G3/8

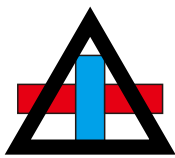

专注于液压增压器的研发

Focus on the research of hydraulic booster

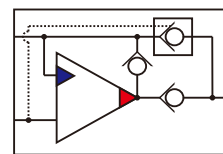

锁紧螺母



安装螺母: M28X1.5
六角尺寸: S32
厚度: 6mm
使用场合: T系列管式增压器固定

超高压接头



通径: 3通径
耐压等级: 150MPa
连接螺纹:

超高压单向阀



通流方向: 反向、正向
通径: 3通径、6通径
耐压等级: 100MPa、250MPa

超高压针阀



通流方向: 直通或90度
通径: 3通径
耐压等级: 100-400Mpa

超高压软管



通径: 3通径
耐压等级: 200MPa、400MPa

超高压快插



通径: 3通径
耐压等级: 160MPa、200MPa

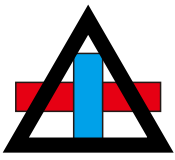

不断创新 追求卓越
Constant innovation, Striving for excellence

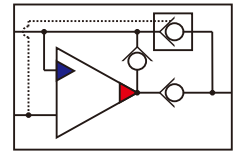

生产设备



诚招全球代理商

Sincerely looking for global agents

液压增压器源头厂家

Hydraulic booster manufacture



宁波市德思宏液压科技有限公司

NingBo Desihom Hydraulic Technology Co.,LTD

地址：浙江省宁波市北仑区新碶镇府路78号

Address: No. 78, Zhenfu Road, Xinqi Town, Beilun District, Ningbo, Zhejiang, China

江西德思宏液压有限公司

Jiangxi Desihon Hydraulic Co.,LTD

地址：江西省宜春市宜丰县工业园工业大道

Adress: Yifeng industrial park ,Yifeng, Yichun, China

手机Mobile: +86 13586873305

邮箱E-mail: sales@desihom.com

网址Web: www.desihom.com www.desihon.com

